

# VHF FM Transceiver VX-160V/-180V Service Manual

©2005 VERTEX STANDARD CO., LTD. EC013N90B

**VERTEX STANDARD CO., LTD.**  
4-8-8 Nakameguro, Meguro-Ku, Tokyo 153-8644, Japan

**VERTEX STANDARD**  
**US Headquarters**  
10900 Walker Street, Cypress, CA 90630, U.S.A.

**YAESU EUROPE B.V.**  
P.O. Box 75525, 1118 ZN Schiphol, The Netherlands

**YAESU UK LTD.**  
Unit 12, Sun Valley Business Park, Winnall Close  
Winchester, Hampshire, SO23 0LB, U.K.

**VERTEX STANDARD HK LTD.**  
Unit 5, 20/F., Seaview Centre, 139-141 Hoi Bun Road,  
Kwun Tong, Kowloon, Hong Kong

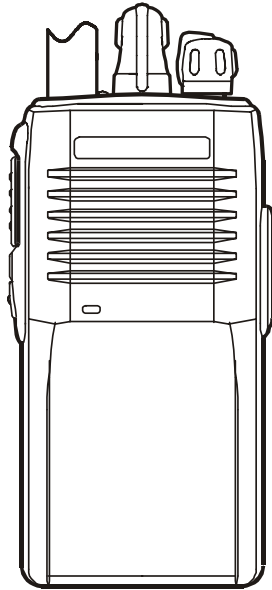

**VX-160V**

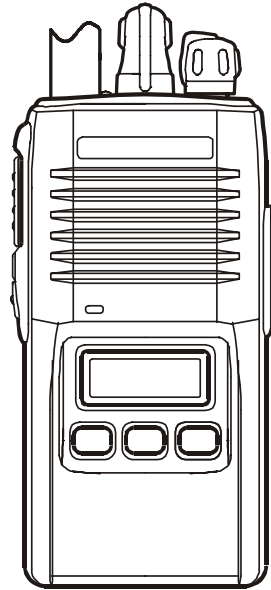

**VX-180V**

## Introduction

This manual provides technical information necessary for servicing the VX-160V and VX-180V FM Transceiver.

Servicing this equipment requires expertise in handling surface-mount chip components. Attempts by non-qualified persons to service this equipment may result in permanent damage not covered by the warranty, and may be illegal in some countries.

Two PCB layout diagrams are provided for each double-sided circuit board in the transceiver. Each side of is referred to by the type of the majority of components installed on that side (“leaded” or “chip-only”). In most cases one side has only chip components, and the other has either a mixture of both chip and leaded components (trimmers, coils, electrolytic capacitors, ICs, etc.), or leaded components only.

While we believe the technical information in this manual to be correct, VERTEX STANDARD assumes no liability for damage that may occur as a result of typographical or other errors that may be present. Your cooperation in pointing out any inconsistencies in the technical information would be appreciated.

## Contents

<b>Operating Manual Reprint.....</b>	<b>2</b>	<b>Block Diagram .....</b>	<b>9</b>
<b>Cloning .....</b>	<b>6</b>	<b>Circuit Description .....</b>	<b>11</b>
<b>Specifications .....</b>	<b>7</b>	<b>Alignment .....</b>	<b>13</b>
<b>Exploded View &amp; Miscellaneous Parts .....</b>	<b>8</b>	<b>Board Unit (Schematics, Layouts &amp; Parts)</b>	
		MAIN Unit.....	17

# Operating Manual Reprint

## Controls & Connectors

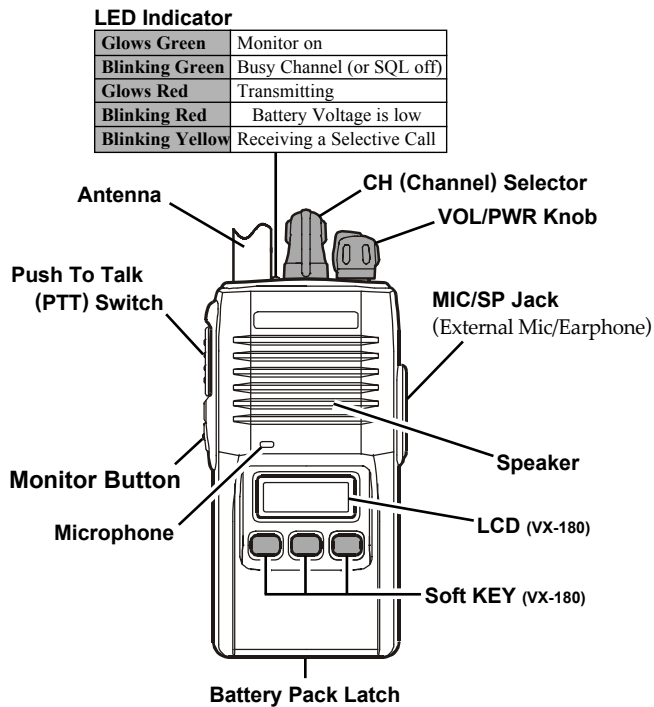

## Display Icons & Indicators (VX-180 Only)

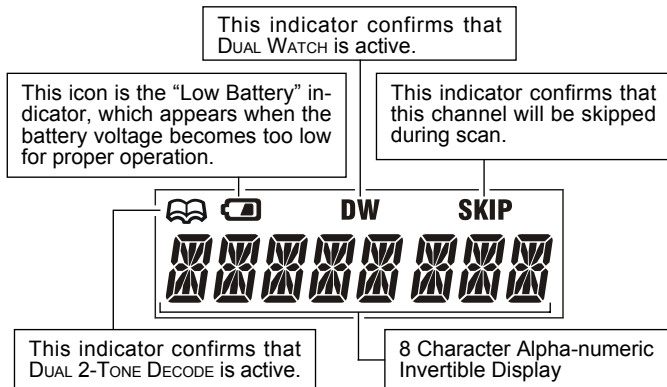

## Before You Begin

### Battery Pack Installation and Removal

- To install the battery, hold the transceiver with your left hand, so your palm is over the speaker and your thumb is on the top of the belt clip. Insert the battery pack into the battery compartment on the back of the radio while tilting the Belt Clip outward, then close the Battery Pack Latch until it locks in place with a "Click."

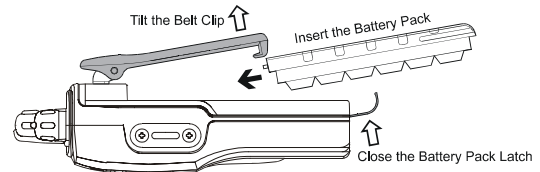

- To remove the battery, turn the radio off and remove any protective cases. Open the Battery Pack latch on the bottom of the radio, then slide the battery downward and out from the radio while holding the Belt Clip.

### Caution!

*Do not attempt to open any of the rechargeable Ni-Cd packs, as they could explode if accidentally short-circuited.*

### Low Battery Indication

- As the battery discharges during use, the voltage gradually becomes lower. When the battery voltage becomes to low, substitute a freshly charged battery and recharge the depleted pack. The **TX/BUSY** indicator on the top of the radio will blink *red* (on the **VX-180**, the "TX/BUSY" icon will appear on the LCD) when the battery voltage is low.
- Avoid recharging Ni-Cd batteries often with little use between charges, as this can degrade the charge capacity. We recommend that you carry an extra, fully-charged pack with you so the operational battery may be used until depletion (this "deep cycling" technique promotes better long-term battery capacity).

## Operation

### Preliminary Steps

- Install a charged battery pack onto the transceiver, as described previously.
- Screw the supplied antenna onto the Antenna jack. Never attempt to operate this transceiver without an antenna connected.
- If you have a Speaker/Microphone, we recommend that it not be connected until you are familiar with the basic operation of the **VX-160/-180**.

### Operation Quick Start

- Turn the top panel's **VOL/PWR** knob clockwise to turn on the radio on.

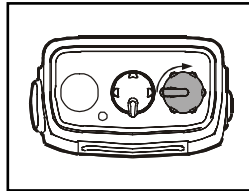

- Turn the top panel's **CH** selector knob to choose the desired operating channel.

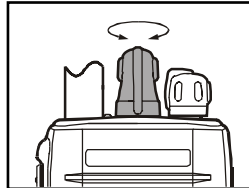

- Rotate the **VOL/PWR** knob to set the volume level. If no signal is present, press and hold in the **MONITOR** key (the lower button on the left side) for more than 1 seconds; background noise will now be heard, and you may use this to set the **VOL/PWR** knob for the desired audio level.

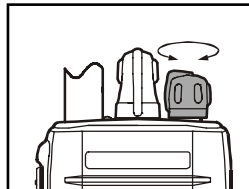

- Press and hold in the **MONITOR** key for more than 1 seconds (or press the **MONITOR** key twice) to quiet the noise and resume normal (quiet) monitoring.

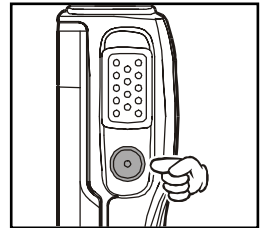

- To transmit, press and hold in the **PTT** switch. Speak into the microphone area of the front panel grille (lower left-hand corner) in a normal voice level. To return to the Receive mode, release the **PTT** switch.

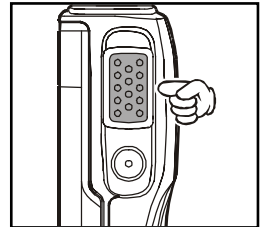

- If a Speaker/Microphone is available, remove the plastic cap and its two mounting screws from the right side of the transceiver, then insert the plug from the Speaker/Microphone into the **MIC/SP** jack; secure the plug using the screws supplied with the Speaker/Microphone. Hold the speaker grille up next to your ear while receiving. To transmit, press the **PTT** switch on the Speaker/Microphone, just as you would on the main transceiver's body.

**Note:** Save the original plastic cap and its mounting screws. They should be re-installed when not using the Speaker/Microphone.

## Key Functions

The **VX-180** provides programmable [A], [B], and [C] function keys, and both the **VX-160** and **VX-180** provide programmable **MONITOR** keys. These “Soft” keys functions can be customized (set to other functions), via programming by your **VERTEX STANDARD** dealer, to meet your communications/network requirements. Some features may require the purchase and installation of optional internal accessories. The possible **Soft** key programming features are illustrated at the right, and their functions are explained in the next chapter. For further details, contact your **VERTEX STANDARD** dealer.

For future reference, check the box next to each function that has been assigned to the **Soft** key on your particular radio, and keep it handy.

Function	Soft Key			
	[A]	[B]	[C]	MONITOR key
None				
Monitor				
Low Power				
Lock*				
Lamp*				
Channel Up*				
Channel Down*				
Scan				
Follow-me Scan				
Dual Watch				
Talk Around				
Add/Del*				
Call/Reset				
Speed Dial				
TX Save Off				

\* VX-180 only

---

## Description of Operating Functions

---

### Monitor

Press the assigned **Soft** key momentarily to override (disable) the Tone squelch.

Background noise or incoming signals will now be heard whether or not a matching tone is present on the signal. Press and hold in the assigned **Soft** key for more than 1 seconds to override both the Noise and Tone squelch. Again press and hold in the assigned **Soft** key for more than 1 seconds (or press the assigned **Soft** key twice) to resume normal (quiet) Noise and Tone squelch action.

### Low Power

Press the assigned **Soft** key to set the radio's transmitter to the "Low Power" mode, thus extending battery life. Press the assigned **Soft** key again to return to "High Power" operation when in difficult terrain.

### Lock

Press the assigned **Soft** key to lock the **Soft** keys (except **Lock** and **Monitor** key); thus, the [A], [B], [C], and **MONITOR** keys can be disabled to prevent radio settings from being disturbed.

### Lamp

Press the assigned **Soft** key to illuminate the LCD for five seconds.

### Channel Up

Press the assigned **Soft** key to switch to a higher operating channel number.

### Channel Down

Press the assigned **Soft** key to switch to a lower operating channel number.

### Scan

The Scanning feature is used to monitor multiple channels programmed into the transceiver. While scanning, the radio will check each channel for the presence of a signal, and will stop on a channel if a signal is present.

To activate scanning:

Press the assigned **Soft** key.

The scanner will search the channels, looking for active ones; it will pause each time it finds a channel on which someone is speaking.

To stop scanning:

Press the assigned **Soft** key.

Operation will revert to the channel to which the **CH** knob is set.

### Follow-Me Scan

"Follow-Me" Scan feature checks a *User-assigned* Priority Channel regularly as you scan the other channels. Thus, if only Channels 1, 3, and 5 (of the 8 available channels) are designated for "Scanning," the user may nonetheless assign Channel as the "User-assigned" Priority Channel via the "Follow-Me" feature.

Press the assigned **Soft** key to activate "Follow-Me" scanning, then turn the **CH** selector knob to the channel which you want to designate as the "User-Assigned Priority Channel". When the scanner stops on an "active" channel, the User-assigned Priority Channel will automatically be checked every few seconds.

### Dual Watch

The Dual Watch feature is similar to the Scan feature, except that only two channels are monitored: the current operating channel, and the "Priority" channel.

To activate Dual Watch:

Press the assigned **Soft** key.

The scanner will search the two channels; it will pause each time it finds a channel on which someone is speaking.

To stop Dual Watch:

Press the assigned **Soft** key.

Operation will revert to the channel to which the **CH** knob is set.

### Talk Around

Press the assigned **Soft** to activate the Talk Around feature when you are operating on duplex channel systems (separate receive and transmit frequencies, utilizing a "repeater" station). The Talk Around feature allows you to bypass the repeater station and talk directly to a station that is nearby. This feature has no effect when you are operating on "Simplex" channels, where the receive and transmit frequencies are already the same.

Note that your dealer may have made provision for "Talk Around" channels by programming "repeater" and "Talk Around" frequencies on two adjacent channels. If so, the key may be used for one of the other Pre-Programmed Functions.

### Add/Del

The Add/Del feature allows the user to arrange a custom Scan.

Press the assigned **Soft** key to delete/restore the current channel to/from your scanning list.

When you delete a current channel, "**SKIP**" will appear on the LCD after pressing the **Soft** key. When you restore a current channel, "**SKIP**" indicator on the LCD will turn off.

---

## Description of Operating Functions

---

### Call/Reset

When the 2-tone selective calling unit is installed, press the assigned **Soft** key to silence the receiver and reset for another call, when a communication is finished.

### Speed Dial

Your Dealer may have pre-programmed Auto-Dial telephone number memories into your radio.

To dial a number, just press the Dealer-assigned **Soft** key for Speed Dialing. The DTMF tones sent during the dialing sequence will be heard in the speaker.

### TX Save Off

Press the assigned **Soft** key to disable the Transmit Battery Saver, if you are operating in a location where high power is almost always needed.

The Transmit Battery Saver helps extend battery life by reducing transmit power when a very strong signal from an apparently nearby station is being received. Under some circumstances, though, your hand-held radio may not be heard well at the other end of the communication path, and high power may be necessary at all times.

---

## Accessories & Options

---

<b>FNB-64</b>	7.2 V 700 mAh Ni-Cd Battery
<b>FNB-V57</b>	7.2 V 1100 mAh Ni-Cd Battery
<b>FBA-25A</b>	Alkaline Battery Case
<b>NC-77B</b>	120 VAC Overnight Desktop Charger
<b>NC-77C</b>	230-240 VAC Overnight Desktop Charger
<b>VAC-800</b>	Desktop Rapid Charger
<b>VAC-6800</b>	6-unit Multi Charger
<b>MH-45<sup>B4B</sup></b>	Speaker/Microphone
<b>MH-37<sup>A4B</sup></b>	Earpiece Microphone
<b>VC-25</b>	VOX Headset
<b>VCM-1</b>	Mobile Mounting Bracket (for VAC-800)
<b>LCC-160/S</b>	Leather Case (for VX-160)
<b>LCC-180/S</b>	Leather Case (for VX-180)
<b>CT-42</b>	PC Programming Cable
<b>CT-27</b>	Radio to Radio Programming Cable
<b>CE44</b>	Programming Software

# Cloning

The **VX-160/-180** includes a convenient “Cloning” feature, which allows the programming data from one transceiver to be transferred to another **VX-160/-180**. Here is the procedure for Cloning one radio's data to another.

1. Turn both transceivers off.
2. Remove the plastic cap and its two mounting screws from the **MIC/SP** jack on the right side of the transceiver. Do this for both transceivers.
3. Connect the optional **CT-27** cloning cable between the **MIC/SP** jacks of the two transceivers.
4. Press and hold in the **PTT** and **MONITOR** switches (just below the PTT switch) while turning the transceiver on. Do this for both transceivers (the order of the switch-on does not matter). “**CLONE**” will appear on the displays (for the **VX-180**) of both transceivers when Clone mode is successfully activated in this step; in the case of the **VX-160**, no change will be observed at this point.
5. On the Destination transceiver, press the **MONITOR** switch. “**LOADING**” will appear on the LCD (for **VX-180**; for **VX-160**, the **TX/BUSY** indicator on the top of the radio will glow Green).
6. Press the **PTT** switch on the source transceiver; “**SENDING**” will appear on the Source transceiver (for **VX-180**; for **VX-160**, the **TX/BUSY** indicator on the top of the radio will glow Red), and the data will be transferred.
7. If there is a problem during the cloning process, “**ERROR**” will appear on the LCD (for **VX-180**; for **VX-160**, the **TX/BUSY** indicator on the top of the radio will blink Red); check your cable connections and battery voltage, and try again.
8. If the data transfer is successful, the display will return to “**CLONE**” (for **VX-180**; for **VX-160**, the **TX/BUSY** indicator on the top of the radio will turn off). Turn both transceivers off and disconnect the **CT-27** cable. You can then turn the transceivers back on, and begin normal operation.
9. Replace the plastic cap and its two mounting screws.

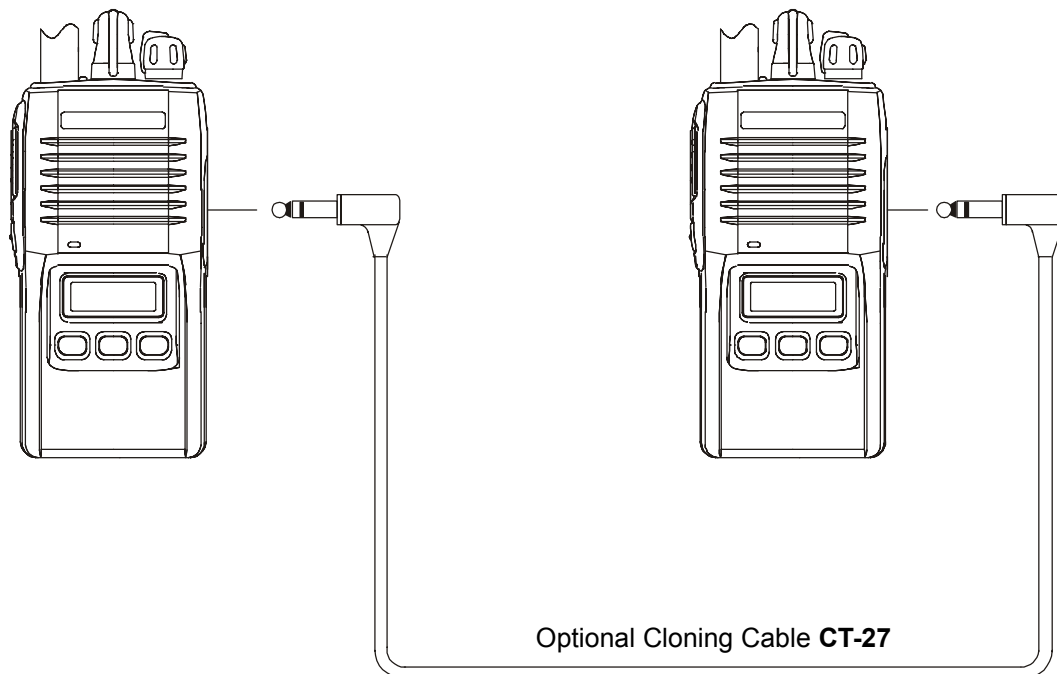

## GENERAL Specifications

<b>Frequency Range (MHz):</b>	134 - 160 (TYP A) 146 - 174 (TYP C) 142 - 176 (TYP CS1)
<b>Number of Channels:</b>	16 channels
<b>Channel Spacing:</b>	12.5 / 25 kHz (15 / 30 kHz)
<b>PLL Steps</b>	2.5 / 6.25 kHz
<b>Power Supply voltage:</b>	7.5 VDC $\pm$ 20%
<b>Operating Temperature Range:</b>	-22°F to +140°F (-30°C to +60°C)
<b>Frequency Stability:</b>	$\pm$ 2.5 ppm
<b>Dimensions (WHD):</b>	2.3" (W) x 4.7" (H) x 1.2" (D) (58 x 120 x 31 mm)
<b>Weight (approx.):</b>	0.81 lb. (365 g) w/FNB-64

## RECEIVER Specifications (Measurements made per EIA standard TIA/EIA-603)

### Sensitivity

EIA 12 dB SINAD : 0.20  $\mu$ V

20 dB Quieting : 0.30  $\mu$ V

**Adjacent channel selectivity:** 65 dB (25 kHz) / 60 dB (12.5 kHz)

**Intermodulation:** 65 dB

**Spurious and Image Rejection:** 65 dB

**Hum & Noise** 45 dB

**Audio output:** 500 mW @4 Ohms, 5% THD

## TRANSMITTER Specifications (Measurements made per EIA standard TIA/EIA-603)

**Power output:** 5.0 / 1.0 W

**Modulation:** 16K0F3E, 11K0F3E

**Conducted Spurious Emissions:** 60 dB Below Carrier

**FM Hum & Noise:** 40 dB (25 kHz) / 35 dB (12.5 kHz)

**Audio distortion (@ 1 kHz):** < 5 %

Measurements per EIA standards unless noted above. Specifications subject to change without notice or obligation.



# Exploded View & Miscellaneous Parts

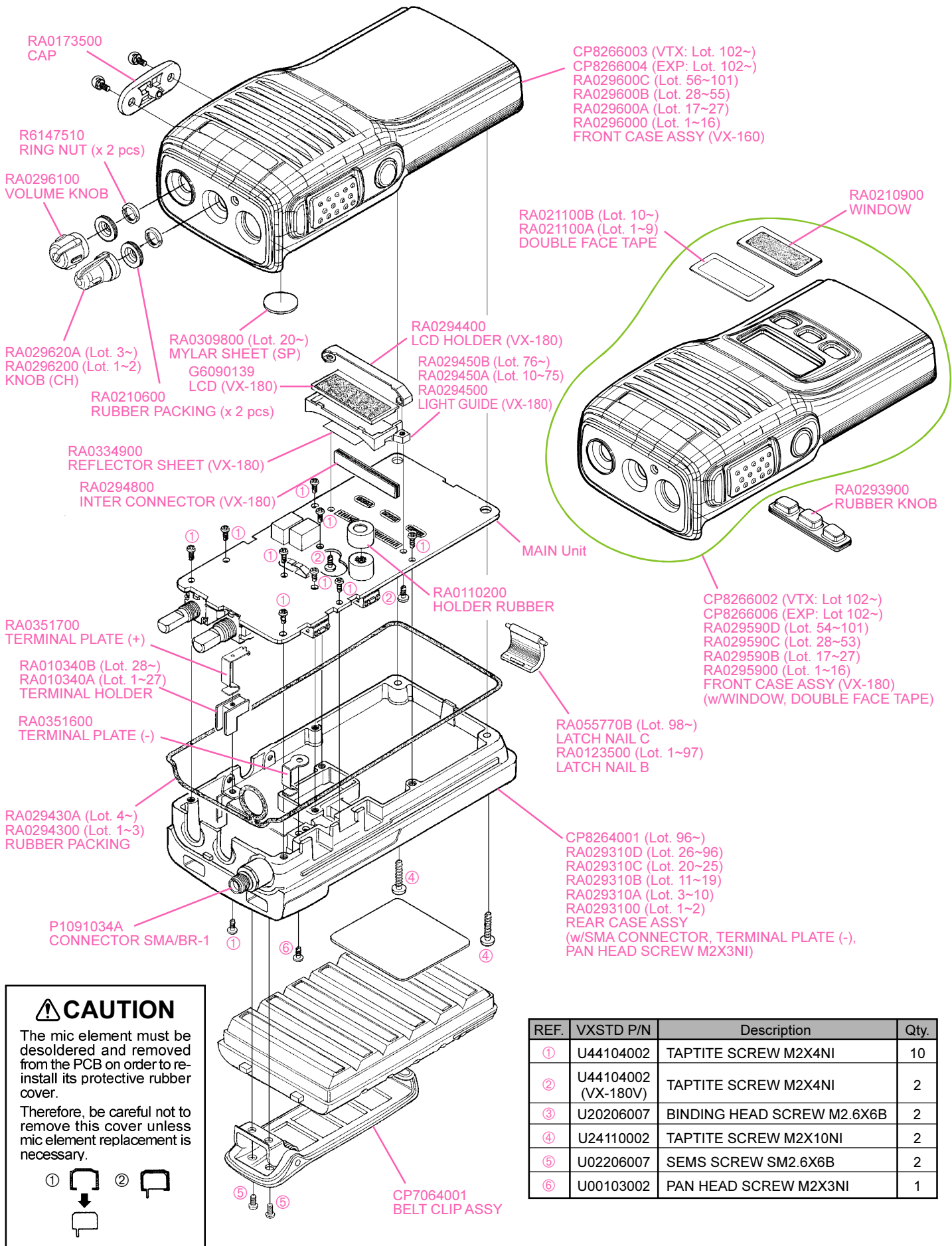

**CAUTION**

The mic element must be desoldered and removed from the PCB in order to re-install its protective rubber cover.

Therefore, be careful not to remove this cover unless mic element replacement is necessary.

REF.	VXSTD P/N	Description	Qty.
①	U44104002	TAPTITE SCREW M2X4NI	10
②	U44104002 (VX-180V)	TAPTITE SCREW M2X4NI	2
③	U20206007	BINDING HEAD SCREW M2.6X6B	2
④	U24110002	TAPTITE SCREW M2X10NI	2
⑤	U02206007	SEMS SCREW SM2.6X6B	2
⑥	U00103002	PAN HEAD SCREW M2X3NI	1





*Note:*

## Receive Signal Path

Incoming RF from the antenna jack is delivered to the RF Unit and passes through a low-pass filter consisting of coils L1001, L1002, and L1031, capacitors C1004, C1005, C1008, C1010, C1014, C1016, and C1221, and antenna switching diode D1003 (**RLS135 TE-17**).

Signals within the frequency range of the transceiver enter a varactor-tuned band-pass filter consisting of coils L1010 and L1011, capacitors C1044, C1046, C1060, C1065, and C1068, and diodes D1011, D1012, D1013, and D1014 (all **HVC358B**), then are amplified by Q1012 (**2SC5006-T1**) and enter a varactor-tuned band-pass filter consisting of coils L1017 and L1021, capacitors C1084, C1086, C1095, and C1097, and diodes D1018, D1019 (both **HVC358B**), before mixing by first mixer Q1026 (**SGM2016AM-T7**).

Buffered output from the VCO is amplified by Q1007 (**2SC5005-T1**) to provide a pure first local signal between 190.25 and 218.25 MHz for injection to the first mixer. The 44.25 MHz first mixer product then passes through monolithic crystal filter XF1002 (typ A, C:**HDF0042**, 5.5 kHz BW or typ CS1:**HDF0051**) to strip away unwanted mixer products, and the IF signal is then amplified by Q1033 (**2SC4215Y TE85R**).

The amplified first IF signal is applied to FM IF subsystem IC Q1037 (**TA31136FN-EL**), which contains the second mixer, second local oscillator, limiter amplifier, noise amplifier, and RSSI amplifier.

The second local signal is produced from the PLL reference/second local oscillator of 14.60 MHz crystal X1001. The 14.60 MHz reference signal is tripled by Q1036, capacitor C1209, and coil L1029, and the resulting 43.8 MHz second local signal is then delivered to the mixer section of Q1037, which produces the 450 kHz second IF when mixed with the first IF signal.

The second IF then passes through ceramic filter CF1001 (**ALFYM450G=K** on “Narrow” channels) or CF1002 (**ALFYM450F=K** on “Wide” channels) to strip away all but the desired signal, and then is applied to the limiter amplifier in Q1037, which removes amplitude variations in the 450 kHz IF, before detection of the speech by the ceramic discriminator, CD1001 (**CDBC450CX24**).

Detected audio from Q1037 is applied to the audio high-pass filter, and then passes via the volume control to the audio amplifier Q1039 (**NJM2070M-TE2**), which provides up to 1/2 Watt to the optional headphone jack or a 4-ohm loudspeaker.

## Squelch Control

The squelch circuitry consists of a noise amplifier and band-pass filter within Q1037, and noise detector D1018 (**HVC358B**).

When no carrier is received, noise at the output of the detector stage in Q1037 is amplified and band-pass filtered by the noise amplifier section of Q1037 and the network between pins 7 and 8, and then is rectified by D1028.

The resulting DC squelch control voltage is passed to pin 37 of the microprocessor Q1014 (**M37516E6HP**:Lot. 1~4, **M37516M6**:Lot. 5~). If no carrier is received, this signal causes pin 24 of Q1014 to go high and pin 20 to go high. Pin 24 signals Q1060 (**RT1P441U-T11-1**) to disable the supply voltage to the audio amplifier Q1039, while pin 20 holds the green (Busy) half of the LED off, when pin 24 is high and pin 20 is high.

Thus, the microprocessor blocks output from the audio amplifier, and silences the receiver, while no signal is being received (and during transmission, as well).

When a carrier appears at the discriminator, noise is removed from the output, causing pin 37 of Q1014 to go low and the microprocessor to activate the “Busy” LED via Q1014.

The microprocessor then checks for CTCSS or CDCSS code squelch information, if enabled. If not transmitting and CTCSS or CDCSS is not activated, or if the received tone or code matches that programmed, audio is allowed to pass through the audio amplifier Q1039 (**NJM2070M TE2**) to the loudspeaker by the enabling of the supply voltage to it via Q1037.

## Transmit Signal Path

Speech input from the microphone is amplified by Q1017 (**NJM2902V TE1**); after pre-emphasis by C1066 and R1054, the audio is amplified in another section of Q1017.

The processed audio may then be mixed with a CTCSS tone generated by Q1014 (**M37516E6HP**:Lot. 1~4, **M37516M6**:Lot. 5~) for frequency modulation of the PLL carrier (up to  $\pm 5$  kHz from the unmodulated carrier) at the transmitting frequency.

If a CDCSS code is enabled for transmission, the code is generated by microprocessor Q1014 (**M37516E6HP**:Lot. 1~4, **M37516M6**:Lot. 5~) and delivered to D1004 (**HVC350B TRF**) for CDCSS modulating.

The modulated signal from the VCO Q1002 (**2SC5231C8-TL**) is buffered by Q1007 (**2SC5005-T1**). The low-level transmit signal then passes through the T/R switching diode D1016 (**DAN235E-TL**) to driver amplifiers Q1015 (**2SC5227-4-TB**) and Q1016 (**2SK2596BXTL**), then the amplified transmit signal is applied to the final amplifier Q1024 (**2SK2974-T11**), which delivers up to 5 watts of output power.

The transmit signal then passes through the antenna switch D1003 (**RLS135 TE-11**) and is low-pass filtered, to suppress harmonic spurious radiation, before delivery to the antenna.

# Circuit Description

## Automatic Transmit Power Control

Current from the final amplifier is sampled by R1108, R1115, and R1125, and is rectified by Q1057 (**IMZ2A T108**). The resulting DC is fed back through Q1032 (**FMW1 T98**) to the drive amplifier Q1016 and final amplifier Q1024, for control of the power output.

The microprocessor selects “High” or “Low” power levels.

## Transmit Inhibit

When the transmit PLL is unlocked, pin 7 of PLL chip Q1005 goes to a logic “Low,” and unlock detector Q1056 (**2SA1586Y TE85R**) goes to a logic “High.” The resulting DC unlock control voltage is passed to pin 14 of the microprocessor, Q1014. While the transmit PLL is unlocked, pin 22 of Q1014 remains high, which then turns off Q1029 (**CPH6102-TL**) and the Automatic Power Controller Q1032 (**FMW1 T98**) to disable the supply voltage to the drive amplifiers Q1015/Q1016 and final amplifier Q1024, thereby disabling the transmitter.

## Spurious Suppression

Generation of spurious products by the transmitter is minimized by the fundamental carrier frequency being equal to final transmitting frequency, modulated directly in the transmit VCO. Additional harmonic suppression is provided by a low-pass filter consisting of coils L1001, L1002, and L1031 plus capacitors C1004, C1005, C1008, C1010, C1014, C1016, and C1221, resulting in more than 60 dB of harmonic suppression prior to delivery of the RF signal to the antenna.

## PLL Frequency Synthesizer

The PLL circuitry on the Main Unit consists of VCO Q1002 (**2SC5231C8-TL**), VCO buffer Q1007 (**2SC5005**), and PLL subsystem IC Q1005 (**MB15A02PFV1-G-BND-EF**), which contains a reference divider, serial-to-parallel data latch, programmable divider, phase comparator, and charge pump.

Frequency stability is maintained by temperature compensating thermistor TH1004. The output from TH1004 is applied to pin 39 of Q1014. Q1014 outputs thermal data to D/A converter Q1052 (**M62364FP 600D**), which produces a DC voltage corresponding to the thermal data. The resulting DC voltage is applied to varactor diode D1004 (**HVC350B TRF**) to stabilize the 14.60 MHz Reference Frequency.

While receiving, VCO Q1002 oscillates between 190.25 and 218.25 MHz according to the transceiver version and the programmed receiving frequency. The VCO output is buffered by Q1007, then applied to the prescaler section of Q1005. There the VCO signal is divided by 64 or 65, according to a control signal from the data latch section of Q1005, before being sent to the programmable divider section of Q1005.

The data latch section of Q1005 also receives serial dividing data from the microprocessor, Q1014, which causes the pre-divided VCO signal to be further divided in the programmable divider section, depending upon the desired receive frequency, so as to produce a 2.5 kHz or 3.125 kHz derivative of the current VCO frequency.

Meanwhile, the reference divider section of Q1005 divides the 14.60 MHz crystal reference (from the reference oscillator, Q1022) by 5840 (or 4672) to produce the 2.5 kHz (or 3.125 kHz) loop references (respectively).

The 2.5 kHz (or 3.125 kHz) signal from the programmable divider (derived from the VCO) and that derived from the reference oscillator are applied to the phase detector section of Q1004, which produces a pulsed output with pulse duration depending on the phase difference between the input signals.

This pulse train is filtered to DC and returned to the varactor D1037 and D1042 (both, typ A, C:**HVC358B** or typ CS1:**1SV305**). Changes in the level of the DC voltage are applied to the varactor, affecting the reference in the tank circuit of the VCO according to the phase difference between the signals derived from the VCO and the crystal reference oscillator.

The VCO is thus phase-locked to the crystal reference oscillator. The output of the VCO Q1002, after buffering by Q1007, is applied to the first mixer as described previously.

For transmission, the VCO Q1002 oscillates between 146 and 174 MHz according to the model version and programmed transmit frequency. The remainder of the PLL circuitry is shared with the receiver. However, the dividing data from the microprocessor is such that the VCO frequency is at the actual transmit frequency (rather than offset for IFs, as in the receiving case). Also, the VCO is modulated by the speech audio applied to D1005 (typ A:**HVU358 TRF**, typ C:**1SV229 TPH3**, typ CS1:**1SV229 TPH3**:Lot. 45~, **HVU358 TRF**:Lot. 54~), as described previously.

Receive and transmit buses select which VCO is made active, using Q1059 and Q1063 (both **RT1P441U-T11-1**).

## Miscellaneous Circuits

### Push-To-Talk Transmit Activation

The PTT switch on the microphone is connected to pin 48 of microprocessor Q1014, so that when the PTT switch is closed, pin 23 of Q1014 goes low. This signal disables the receiver by disabling the 5 V supply bus at Q1036 (**DTB123EK T146**) to the front-end, FM IF subsystem IC Q1037, and the receiver VCO circuitry.

At the same time, Q1027 (**FMW1 T98**) and Q1029 (**CPH6102-TL**) activate the transmit 5V supply line to enable the transmitter.

## Introduction

The **VX-160/-180** has been aligned at the factory for the specified performance across the entire frequency range specified. Realignment should therefore not be necessary except in the event of a component failure. All component replacement and service should be performed only by an authorized Vertex Standard representative, or the warranty policy may be voided.

The following procedures cover the sometimes critical and tedious adjustments that are not normally required once the transceiver has left the factory. However, if damage occurs and some parts are replaced, realignment may be required. If a sudden problem occurs during normal operation, it is likely due to component failure; realignment should not be done until after the faulty component has been replaced.

We recommend that servicing be performed only by authorized Vertex Standard service technicians who are experienced with the circuitry and fully equipped for repair and alignment. Therefore, if a fault is suspected, contact the dealer from whom the transceiver was purchased for instructions regarding repair. Authorized Vertex Standard service technicians realign all circuits and make complete performance checks to ensure compliance with factory specifications after replacing any faulty components. Those who do undertake any of the following alignments are cautioned to proceed at their own risk. Problems caused by unauthorized attempts at realignment are not covered by the warranty policy. Also, Vertex Standard must reserve the right to change circuits and alignment procedures in the interest of improved performance, without notifying owners. Under no circumstances should any alignment be attempted unless the normal function and operation of the transceiver are clearly understood, the cause of the malfunction has been clearly pinpointed and any faulty components replaced, and the need for realignment determined to be absolutely necessary. The following test equipment (and thorough familiarity with its correct use) is necessary for complete realignment. Correction of problems caused by misalignment resulting from use of improper test equipment is not covered under the warranty policy. While most steps do not require all of the equipment listed, the interactions of some adjustments may require that more complex adjustments be performed afterwards. Do not attempt to perform only a single step unless it is clearly isolated electrically from all other steps. Have all test equipment ready before beginning, and follow all of the steps in a section in the order presented.

## Required Test Equipment

- Avionics Radio Tester with calibrated output level at 500 MHz
- In-line Wattmeter with 5% accuracy at 500 MHz
- 50-ohm, 10-W RF Dummy Load
- Regulated DC Power Supply (standard 7.5V DC, 2A)
- Frequency Counter:  $\pm 0.2$  ppm accuracy at 500 MHz
- AF Signal Generator
- AC Voltmeter
- DC Voltmeter
- UHF Sampling Coupler
- IBM PC/compatible Computer with Microsoft DOS v3.0 or later operating system
- Vertex Standard CT-42 Connection Cable and CE44 Alignment program

## Alignment Preparation & Precautions

A 50-ohm RF Dummy load and in-line wattmeter must be connected to the main antenna jack in all procedures that call for transmission, except where specified otherwise. Correct alignment is not possible with an antenna.

After completing one step, read the following step to determine whether the same test equipment will be required. If not, remove the test equipment (except dummy load and wattmeter, if connected) before proceeding.

Correct alignment requires that the ambient temperature be the same as that of the transceiver and test equipment, and that this temperature be held constant between 20° and 30°C (68°~86°F). When the transceiver is brought into the shop from hot or cold air, it should be allowed time to come to room temperature before alignment.

Whenever possible, alignments should be made with oscillator shields and circuit boards firmly affixed in place. Also, the test equipment must be thoroughly warmed up before beginning.

**Note:** Signal levels in dB referred to in this procedure are based on  $0 \text{ dB}\mu = 0.5 \mu\text{V}$  (closed circuit).

### Important Note

When connecting the **CT-42** plug into the **MIC/SP** jack of the **VX-160/-180**, you must remove the plastic cap and its mounting screws prior to programming. Please remember to re-attach the cap and screws when the programming is complete.

# Alignment

Set up the test equipment as shown below for transceiver alignment, and apply 7.5V DC power to the transceiver.

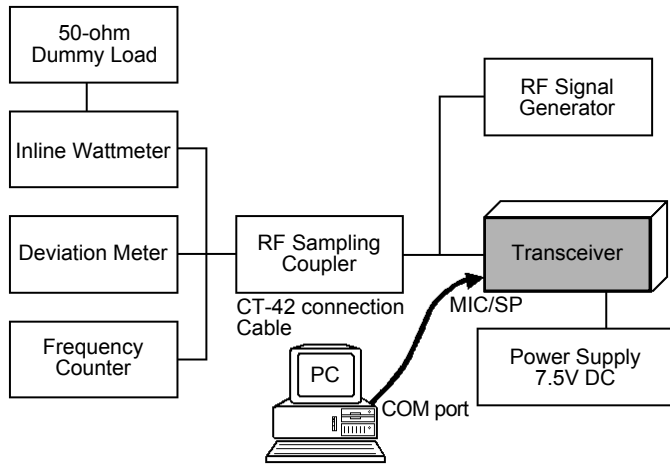

The transceiver must be programmed for use in the intended system before alignment is attempted. The RF parameters are loaded from the file during the alignment process.

In order to facilitate alignment over the complete operating range of the equipment, it is recommended that the channel data in the transceiver be preset as per the chart below.

Channels	Frequency (MHz)		
	Ver. A	Ver. C	Ver. CS1
Low Band Edge (Channel 1)	134.000 (Low POWER)	146.000 (Low POWER)	142.000 (Low POWER)
Band Center (Channel 2)	147.000 (High POWER)	160.000 (High POWER)	159.000 (High POWER)
High Band Edge (Channel 3)	160.000 (High POWER)	174.000 (High POWER)	176.000 (High POWER)

Channel	Tone-Frequency (Hz) / DCS-code					
	Ver. A		Ver. C		Ver. CS1	
	CTCSS	DCS	CTCSS	DCS	CTCSS	DCS
Low Band Edge (Channel 1)	-	-	-	-	-	-
Band Center (Channel 2)	151.4	-	151.4	-	151.4	-
High Band Edge (Channel 3)	-	627	-	627	-	627

## The alignment tool outline

### Installation of the Alignment tool

The "alignment mode" is a software-based protocol, accessed by an "Alignment Mode" command from the computer while switching the transceiver on. It is operated by the alignment tool automatically. During use of the alignment mode, normal operation is suspended. The alignment tool program provides all needed operation capability.

The alignment tool consists of an executable file "CE44.exe" and an accompanying configuration file "CE44.cfg" which should be loaded per standard DOS procedures. Create a suitable directory, then copy these files from the distribution diskette into the new directory.

For example, if copying the file from Drive A, use the following DOS command sequence:

```
c:\ mkdir align [enter]
c:\ cd align [enter]
c:\ align\ copy a:ce44.*
```

No further installation steps are required. If you wish to utilize a different name for the alignment directory, it will not matter to the executable file.

### Booting the Alignment Tool

Change to the "align" directory (or the directory name you utilized in the previous section). Now type on the command line: ce44 [ENTER] to boot the alignment tool.

The introductory screen will appear, and you may press any key to enter the main screen.

### Entering Alignment Mode

To enter the alignment mode, turn the transceiver off, Select "Radio" then "Adjust" parameter. Now, turn the transceiver back on. When the command has been successful, a message on the computer screen will confirm that the transceiver is now in the "Alignment" mode.

### Alignment Sequence

Although the data displayed on the computer's screen during alignment is temporary data, it is important you follow the basic alignment sequence precisely, so that the displayed data and the data loaded into the transceiver are identical.

#### Basic Alignment Sequence

1. Enter the alignment mode
2. Upload data from transceiver
3. Align data
4. Download data to transceiver

## PLL VCV (Varactor Control Voltage)

- Connect the DC voltmeter between **TP3** on the Main Unit and ground.
- Set the transceiver to CH 3 (high band edge), and adjust **L1004** on the Main Unit for 3.7~3.8 V (Typ C), 3.0~3.1 V (Typ CS1) or 3.4~3.5 V (Typ A) on the DC voltmeter.

## Transmitter Output Power

### High Power

- Set the transceiver to CH 2 (band center).
- Open the “Adjust” window on the CE44 program, then select the “RF Power (High)” parameter.
- Press the [ENTER] key to enable programming of this parameter; use the [←] or [→] arrow keys so that the power meter reading is  $5.5\text{ W} \pm 0.1\text{ W}$  (Typ C, CS1) or  $5.0\text{ W} \pm 0.1\text{ W}$  (Typ A). Confirm that the current consumption is 2.2 A or lower.
- Press the [ENTER] key to lock in the new data.

### Low Power

- Set the transceiver to CH 1 (Low band edge).
- Open the “Adjust” window on the CE44 program, then select the “RF Power (Low)” parameter.
- Press the [ENTER] key to enable programming of this parameter; use the [←] or [→] arrow keys so that the power meter reading is  $1.0\text{ W} \pm 0.1\text{ W}$  (for “RF Power Low”). Confirm that the current consumption is 1.0 A or lower.
- Press the [ENTER] key to lock in the new data.

## MIC Sensitivity

- Set the transceiver to CH 2 (band center).
- Inject a 1 kHz tone at -37 dBm to the MIC jack.

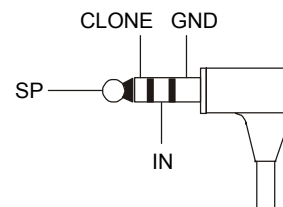

- Open the “Adjust” window on CE44, then select the “MIC Sensitivity” parameter.
- Press the [ENTER] key to enable programming of this parameter; use the [←] or [→] arrow keys so that the deviation meter reading is  $\pm 3.0\text{ kHz}$  ( $\pm 0.1\text{ kHz}$  (for 25 kHz steps) deviation).
- Press the [ENTER] key to lock in the new data.

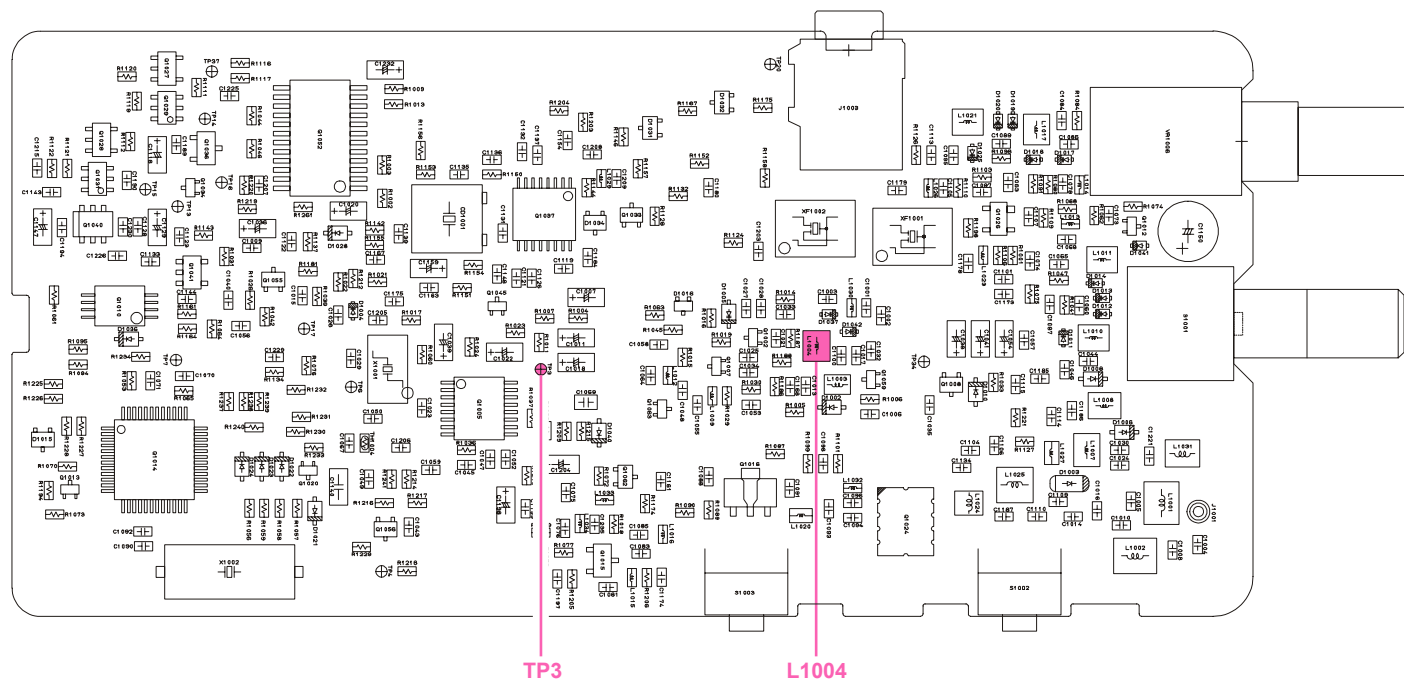



# Alignment

## MAX Deviation

- Set the transceiver to CH 2 (band center).
- Inject a 1 kHz tone at  $-17$  dBm to the **MIC** jack.
- Open the “**Adjust**” window on CE44, then select the “**MAX Deviation**” parameter.
- Press the [ENTER] key to enable programming of this parameter; use the [←] or [→] arrow keys so that the deviation meter reading is  $\pm 4.2$  kHz ( $\pm 0.1$  kHz) (for 25 kHz steps, Typ A, C),  $\pm 4.3$  kHz ( $\pm 0.1$  kHz) (for 25 kHz steps, Typ CS1) or  $\pm 2.1$  kHz ( $\pm 0.1$  kHz) (for 12.5 kHz steps) deviation.
- Press the [ENTER] key to lock in the new data.

## CTCSS Deviation

- Set the transceiver to CH 2 (band center).
- Open the “**Adjust**” window on CE44, then select the “**CTCSS Deviation**” parameter.
- Press the [ENTER] key to enable programming of this parameter; use the [←] or [→] arrow keys so that the deviation meter reading is  $\pm 0.7$  kHz ( $\pm 0.1$  kHz) (for 25 kHz steps, Typ C, A),  $\pm 0.9$  kHz ( $\pm 0.1$  kHz) (for 25 kHz steps, Typ CS1) or  $\pm 0.35$  kHz ( $\pm 0.1$  kHz) (for 12.5 kHz steps, Typ C, A),  $\pm 0.5$  kHz ( $\pm 0.1$  kHz) (for 12.5 kHz steps, Typ CS1) deviation.
- Press the [ENTER] key to lock in the new data.

## DCS Deviation

- Set the transceiver to CH 3 (high band edge).
- Open the “**Adjust**” window on CE44, then select the “**DCS Deviation**” parameter.
- Press the [ENTER] key to enable programming of this parameter; use the [←] or [→] arrow keys so that the deviation meter reading is  $\pm 0.75$  kHz ( $\pm 0.1$  kHz) (for 25 kHz steps) or  $\pm 0.35$  kHz ( $\pm 0.1$  kHz) (for 12.5 kHz steps) deviation.
- Press the [ENTER] key to lock in the new data.

## RF Frequency

- Set the transceiver to CH 2 (band center).
- Open the “**Adjust**” window on CE44, then select the “**RF Frequency**” parameter.
- Press the [ENTER] key to enable programming of this parameter; use the [←] or [→] arrow keys so that the frequency counter displays the band center frequency ( $\pm 100$  Hz) for the version being aligned.
- Press the [ENTER] key to lock in the new data.

## Sensitivity

- Set the transceiver to CH 3 (high band edge, Typ C, A) or CH 1 (low band edge, Typ CS1).
- Tune the RF signal generator to the same frequency as the transceiver's, then set the generator output level to 40 dB $\mu$  with  $\pm 3.0$  kHz deviation @ 1 kHz tone modulation.
- Open the “**Adjust**” window on CE44, then select the “**RX Tune**” parameter.
- Press the [ENTER] key to enable programming of this parameter. Use the [←] or [→] arrow keys to tune for best sensitivity; ultimately, the radio should be aligned so that the RF signal generator output level is  $-6$  dB $\mu$  EMF (0.25  $\mu$ V) or less for 12 dB SINAD.
- Press the [ENTER] key to lock in the new data.



*Note:*



Parts Layout (Side A)

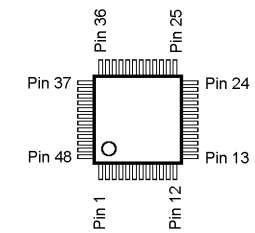
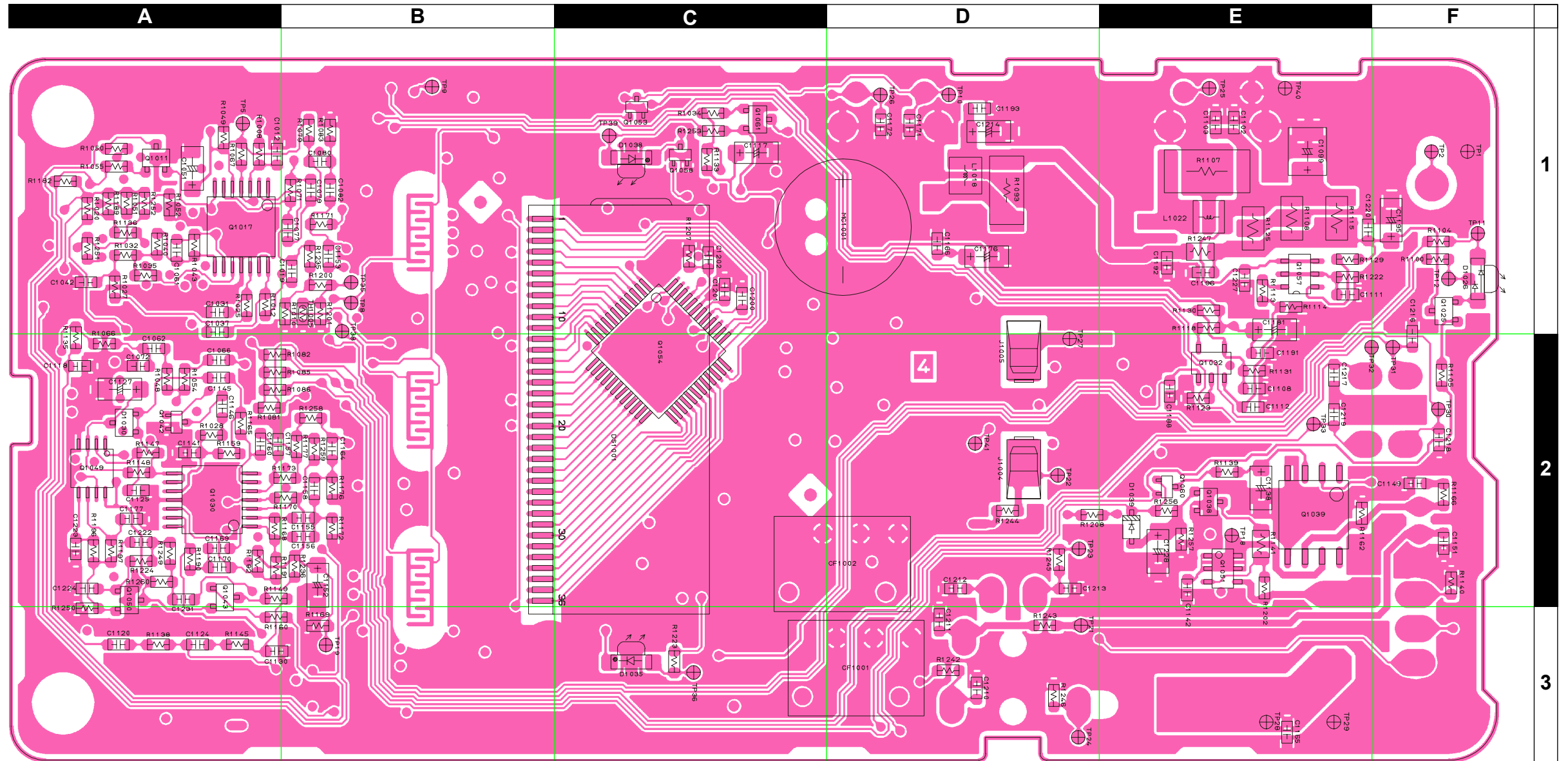

LC75834W (Q1054)

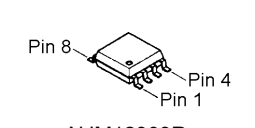

NJM12903R (Q1049)

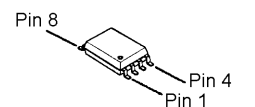

NJM2070M (Q1039)

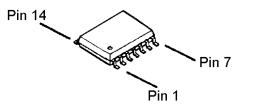

NJM2902V (Q1017, 1030)

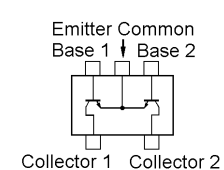

FMW1 (W1) (Q1032)

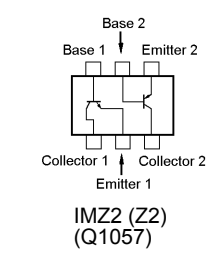

IMZ2 (Z2) (Q1057)

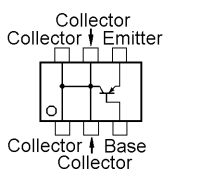

CPH6102 (AB) (Q1051)

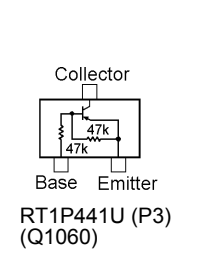

RT1P441U (P3) (Q1060)

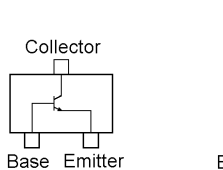

2SC4154E (LE) (Q1025, 1038, 1050, 1061)

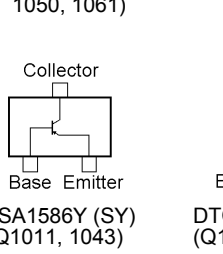

2SA1586Y (SY) (Q1011, 1043)

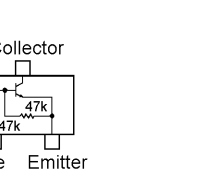

RT1N441U (N3) (Q1042, 1053)

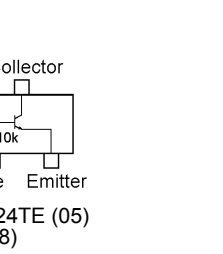

DTC124TE (05) (Q1058)

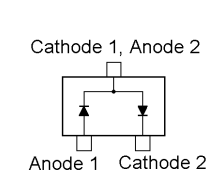

MC2850 (A7) (D1030)

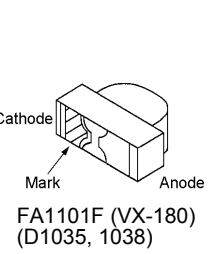

FA1101F (VX-180) (D1035, 1038)

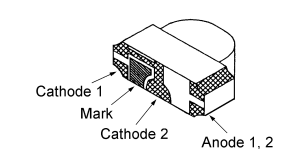

12-22SURSYGC/S530-A2/TR8 (D1026)

# MAIN Unit (Lot. 1~2)

## Parts Layout (Side B)

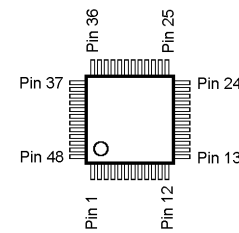
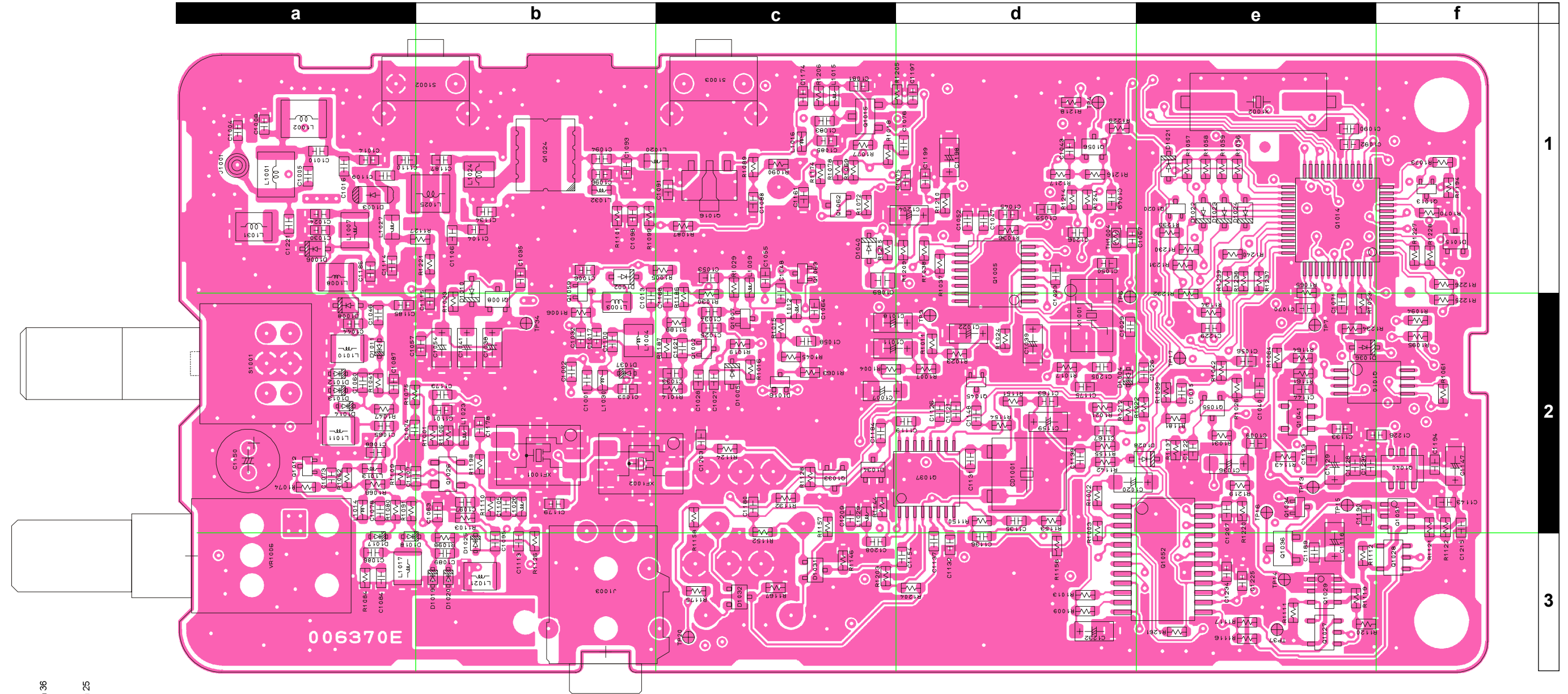

M37516E6HP (Q1014)

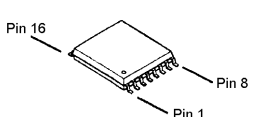

TA31136FN (Q1037)

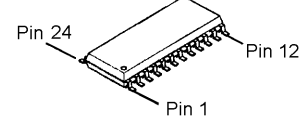

M62364FP (Q1052)

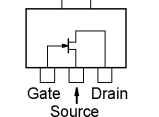

2SK2596 (BX) (Q1016)

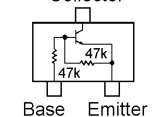

RT1N441U (N3) (Q1034, 1045, 1063)

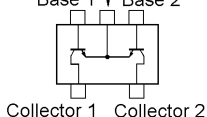

FMW1 (W1) (Q1027, 1028)

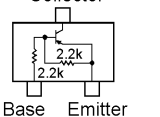

DTB123EK (F12) (Q1036)

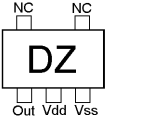

S-80735SN (DZ) (Q1041)

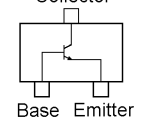

2SC4154E (LE) (Q1008, 1055)  
2SC5005 (73) (Q1007)  
2SC5006 (24) (Q1012)  
2SC4215Y (QY) (Q1033)  
2SC5227 (LN) (Q1015)  
2SC5231 (C8) (Q1002)

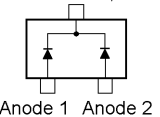

DAN235E (M) (D1016)

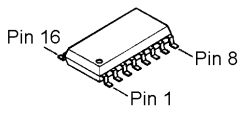

MB15A02PFV1 (Q1005)

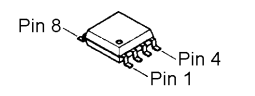

BR93LC66FV (Q1010)

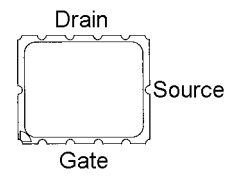

2SK2974 (Q1024)

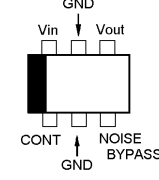

TK11250BMCL (Q1040)

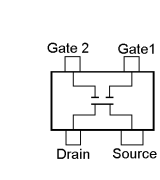

SGM2016AM (MA) (Q1026)

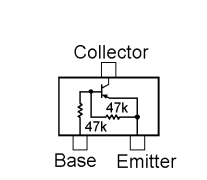

RT1P441U (P3) (Q1013, 1020, 1059)

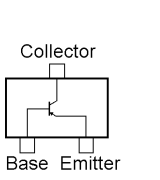

2SA1586Y (SY) (Q1056, 1062)

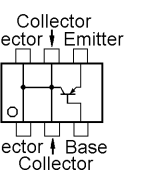

CPH6102 (AB) (Q1029, 1031)

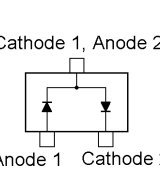

MC2850 (A7) (D1015, 1031, 1032, 1034)





*Note:*



Parts Layout (Side A)

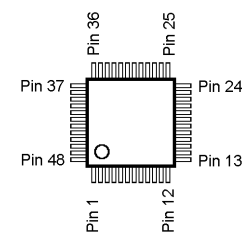
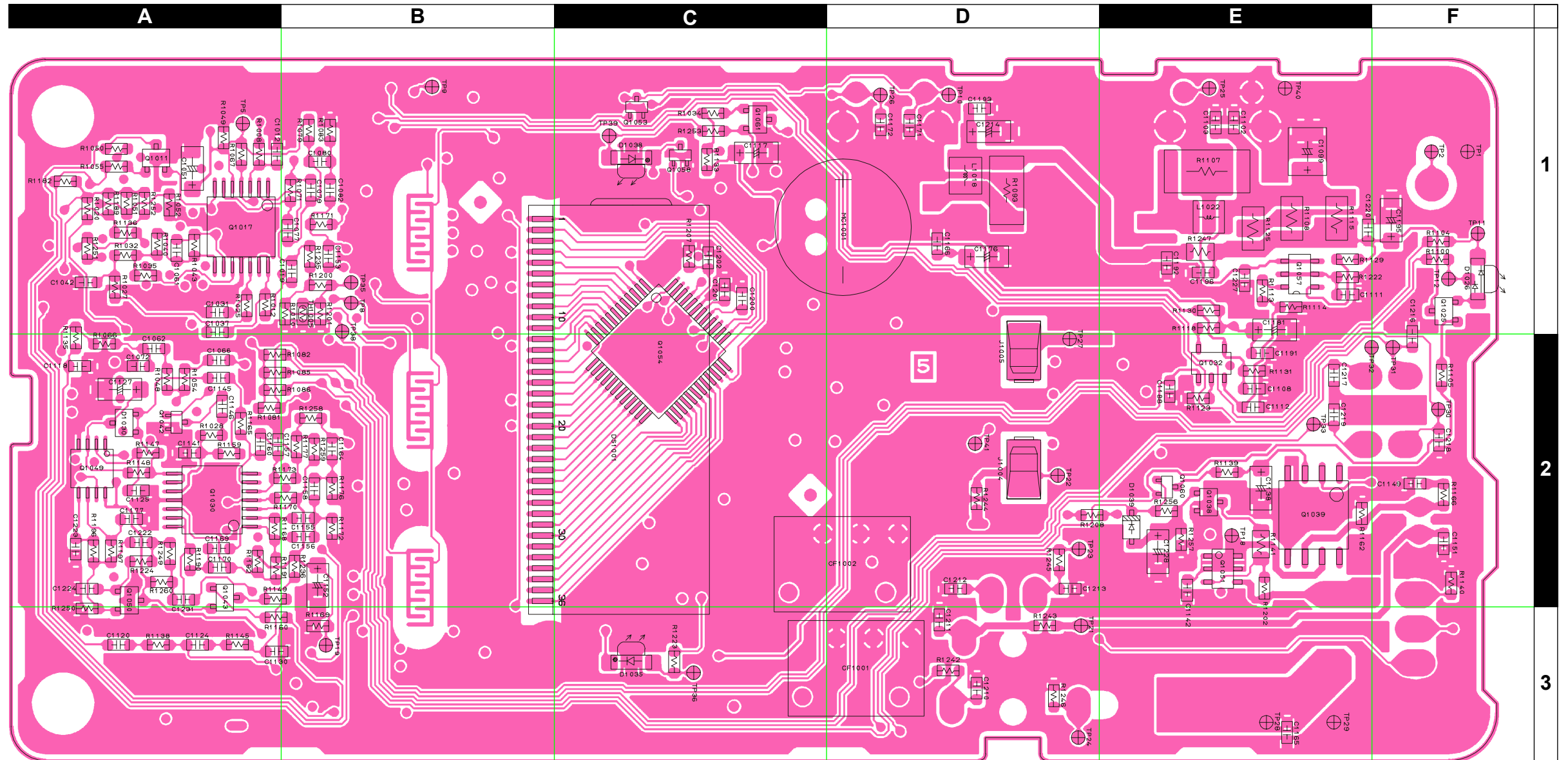

LC75834W (Q1054)

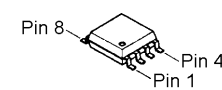

NJM12903R (Q1049)

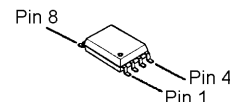

NJM2070M (Q1039)

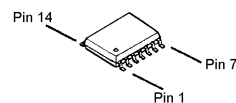

NJM2902V (Q1017, 1030)

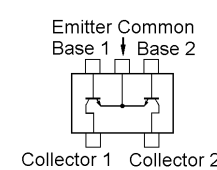

FMW1 (W1) (Q1032)

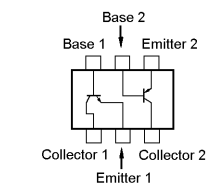

IMZ2 (Z2) (Q1057)

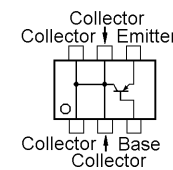

CPH6102 (AB) (Q1051)

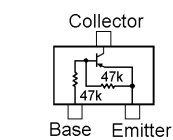

RT1P441U (P3) (Q1060)

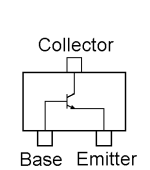

2SC4154E (LE) (Q1025, 1038, 1050, 1061)

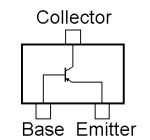

2SA1586Y (SY) (Q1011, 1043)

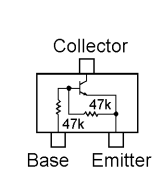

RT1N441U (N3) (Q1042, 1053)

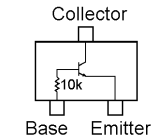

DTC124TE (05) (Q1058)

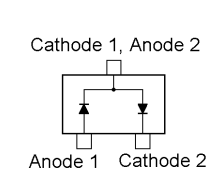

MC2850 (A7) (D1030)

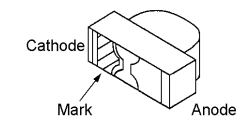

FA1101F (VX-180) (D1035, 1038)

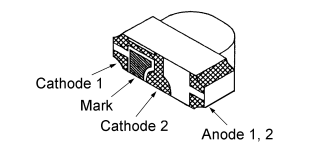

12-22SURSYGC/S530-A2/TR8 (D1026)

# MAIN Unit (Lot. 3~17)

## Parts Layout (Side B)

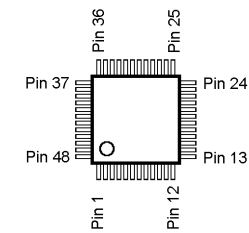
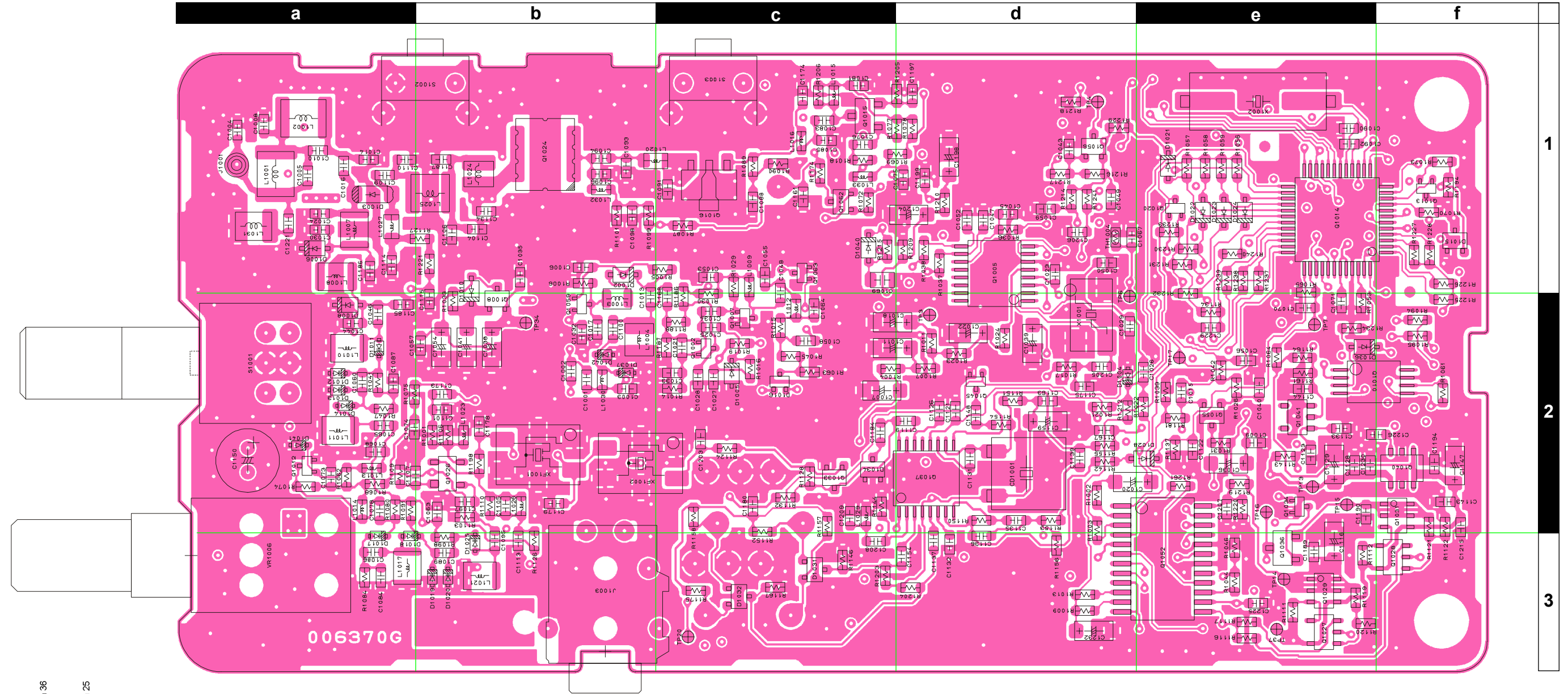

M37516M6 (Q1014)

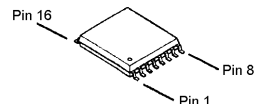

TA31136FN (Q1037)

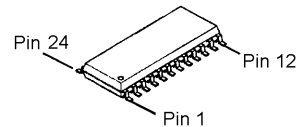

M62364FP (Q1052)

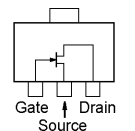

2SK2596 (BX) (Q1016)

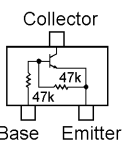

RT1N441U (N3) (Q1034, 1045, 1063)

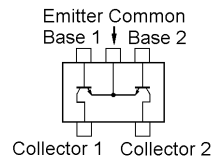

FMW1 (W1) (Q1027, 1028)

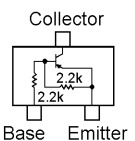

DTB123EK (F12) (Q1036)

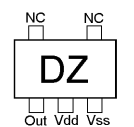

S-80735SN (DZ) (Q1041)

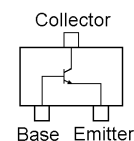

2SC4154E (LE) (Q1008, 1055)  
2SC5005 (73) (Q1007)  
2SC5006 (24) (Q1012)  
2SC4215Y (QY) (Q1033)  
2SC5227 (LN) (Q1015)  
2SC5231 (C8) (Q1002)

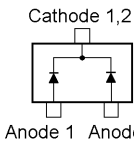

DAN235E (M) (D1016)

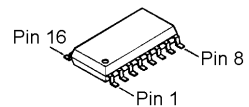

MB15A02PFV1 (Q1005)

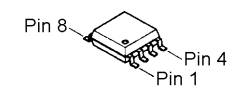

BR93LC66FV (Q1010)

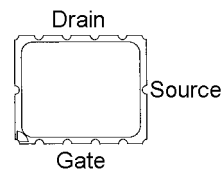

2SK2974 (Q1024)

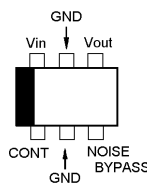

TK11250BMCL (Q1040)

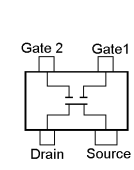

SGM2016AM (MA) (Q1026)

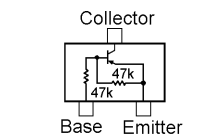

RT1P441U (P3) (Q1013, 1020, 1059)

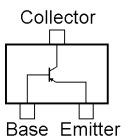

2SA1586Y (SY) (Q1056, 1062)

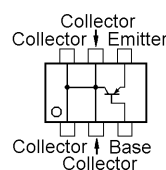

CPH6102 (AB) (Q1029, 1031)

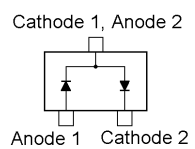

MC2850 (A7) (D1015, 1031, 1032, 1034)



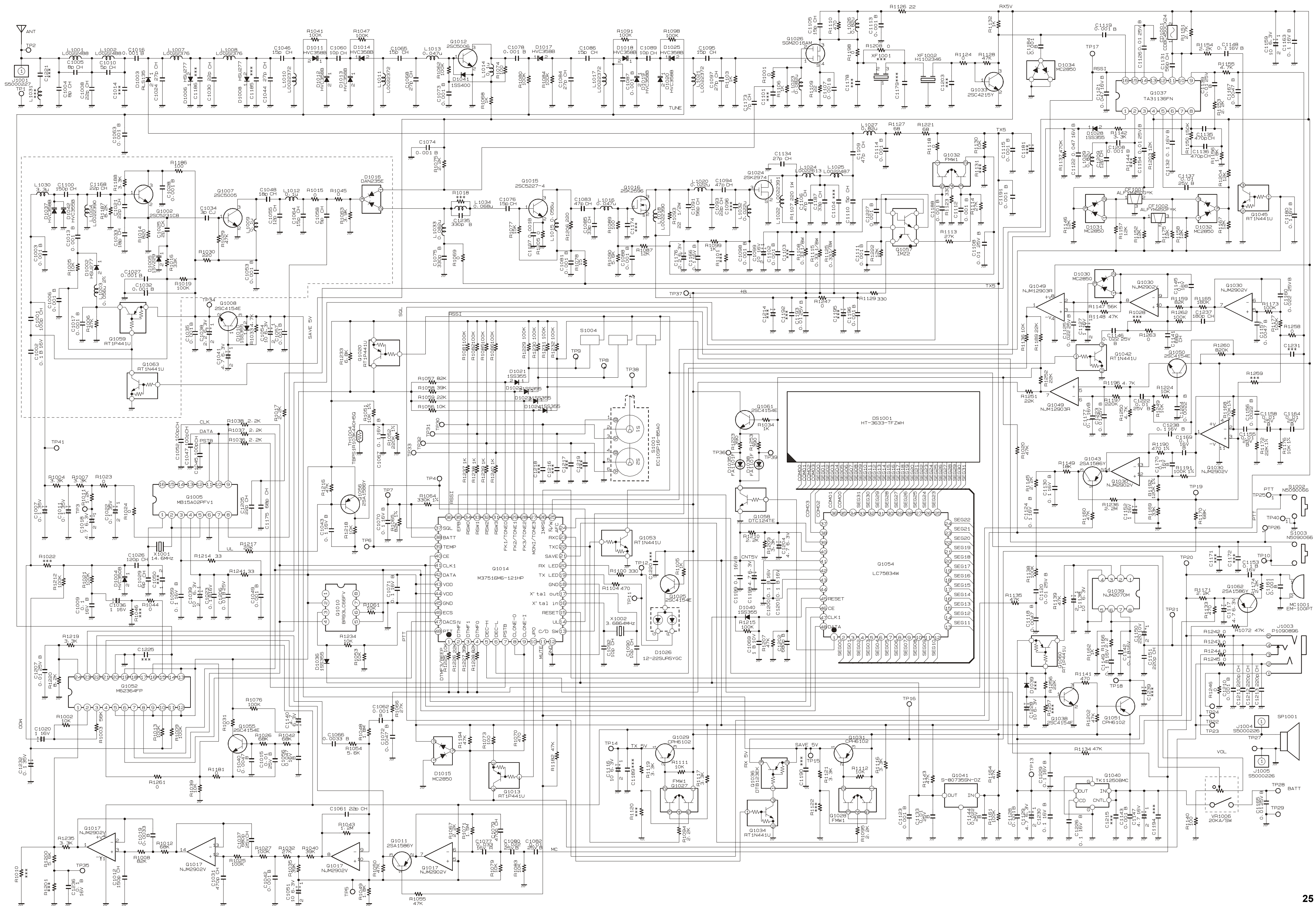

*Note:*

Parts Layout (Side A)

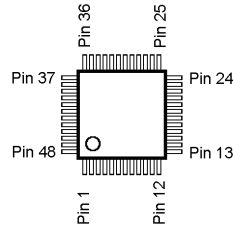
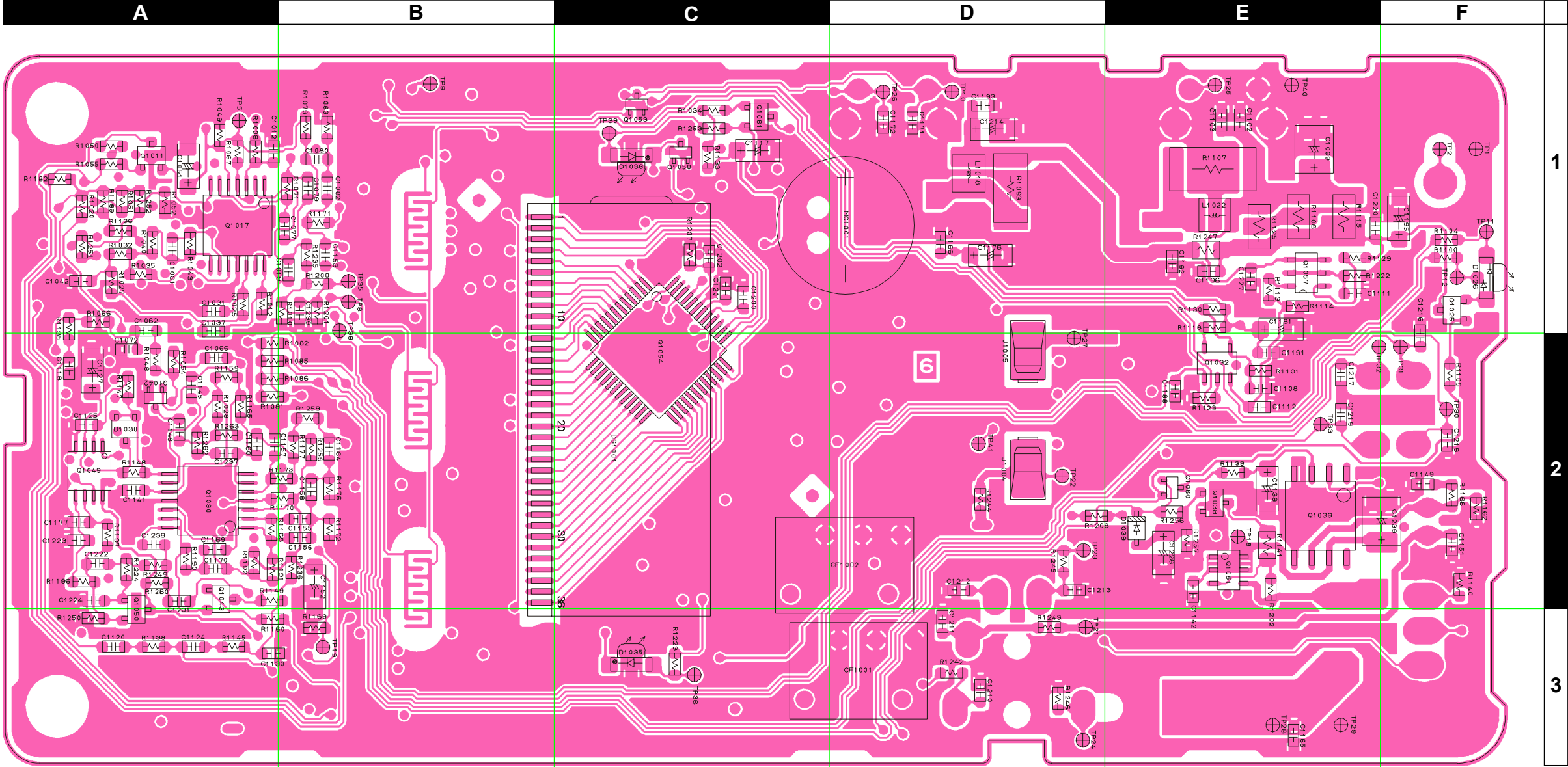

LC75834W (Q1054)

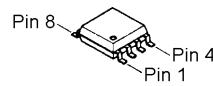

NJM12903R (Q1049)

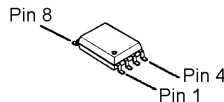

NJM2070M (Q1039)

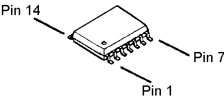

NJM2902V (Q1017, 1030)

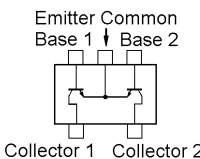

FMW1 (W1) (Q1032)

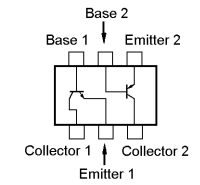

IMZ2 (Z2) (Q1057)

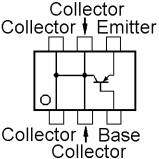

CPH6102 (AB) (Q1051)

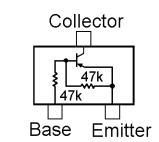

RT1P441U (P3) (Q1060)

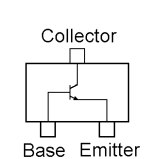

2SC4154E (LE) (Q1025, 1038, 1050, 1061)

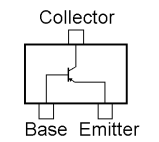

2SA1586Y (SY) (Q1011, 1043)

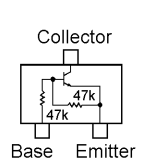

RT1N441U (N3) (Q1042, 1053)

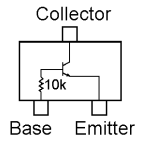

DTC124TE (05) (Q1058)

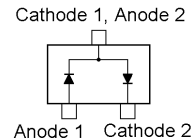

MC2850 (A7) (D1030)

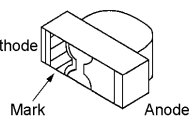

FA1101F (VX-180) (D1035, 1038)

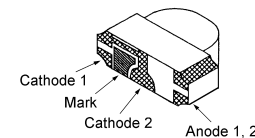

12-22SURSYGC/S530-A2/TR8 (D1026)



Parts Layout (Side B)

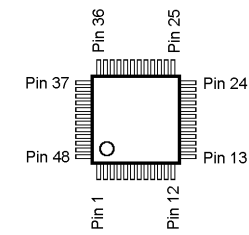
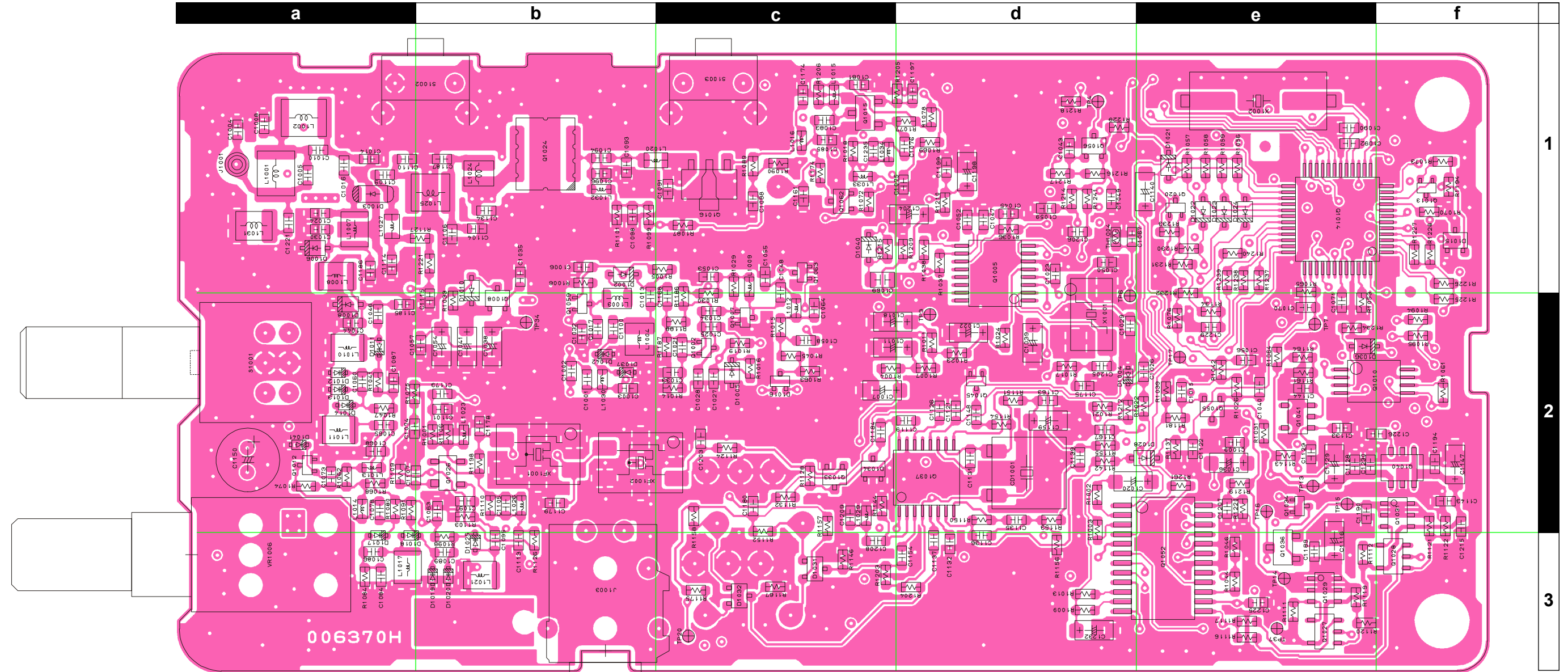

M37516M6 (Q1014)

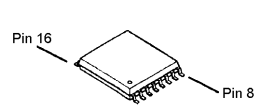

TA31136FN (Q1037)

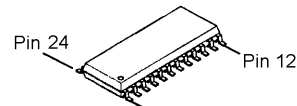

M62364FP (Q1052)

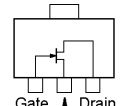

2SK2596 (BX) (Q1016)

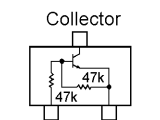

RT1N441U (N3) (Q1034, 1045, 1063)

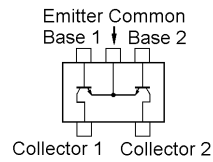

FMW1 (W1) (Q1027, 1028)

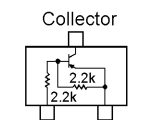

DTB123EK (F12) (Q1036)

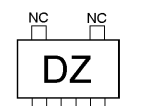

S-80735SN (DZ) (Q1041)

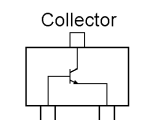

2SC4154E (LE) (Q1008, 1055)  
2SC5005 (73) (Q1007)  
2SC5006 (24) (Q1012)  
2SC4215Y (QY) (Q1033)  
2SC5227 (LN) (Q1015)  
2SC5231 (C8) (Q1002)

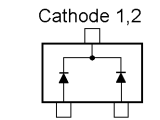

DAN235E (M) (D1016)

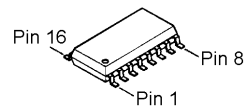

MB15A02PFV1 (Q1005)

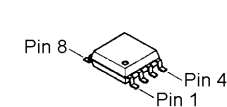

BR93LC66FV (Q1010)

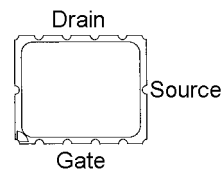

2SK2974 (Q1024)

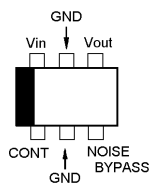

TK11250BMCL (Q1040)

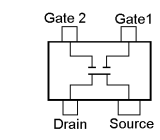

SGM2016AM (MA) (Q1026)

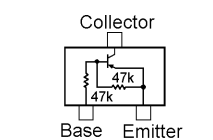

RT1P441U (P3) (Q1013, 1020, 1059)

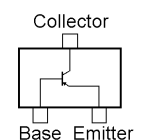

2SA1586Y (SY) (Q1056, 1062)

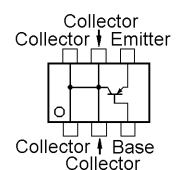

CPH6102 (AB) (Q1029, 1031)

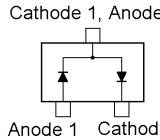

MC2850 (A7) (D1015, 1031, 1032, 1034)





*Note:*

Parts Layout (Side A)

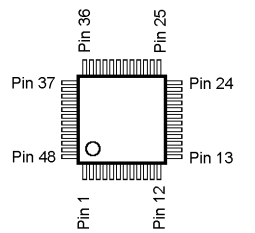
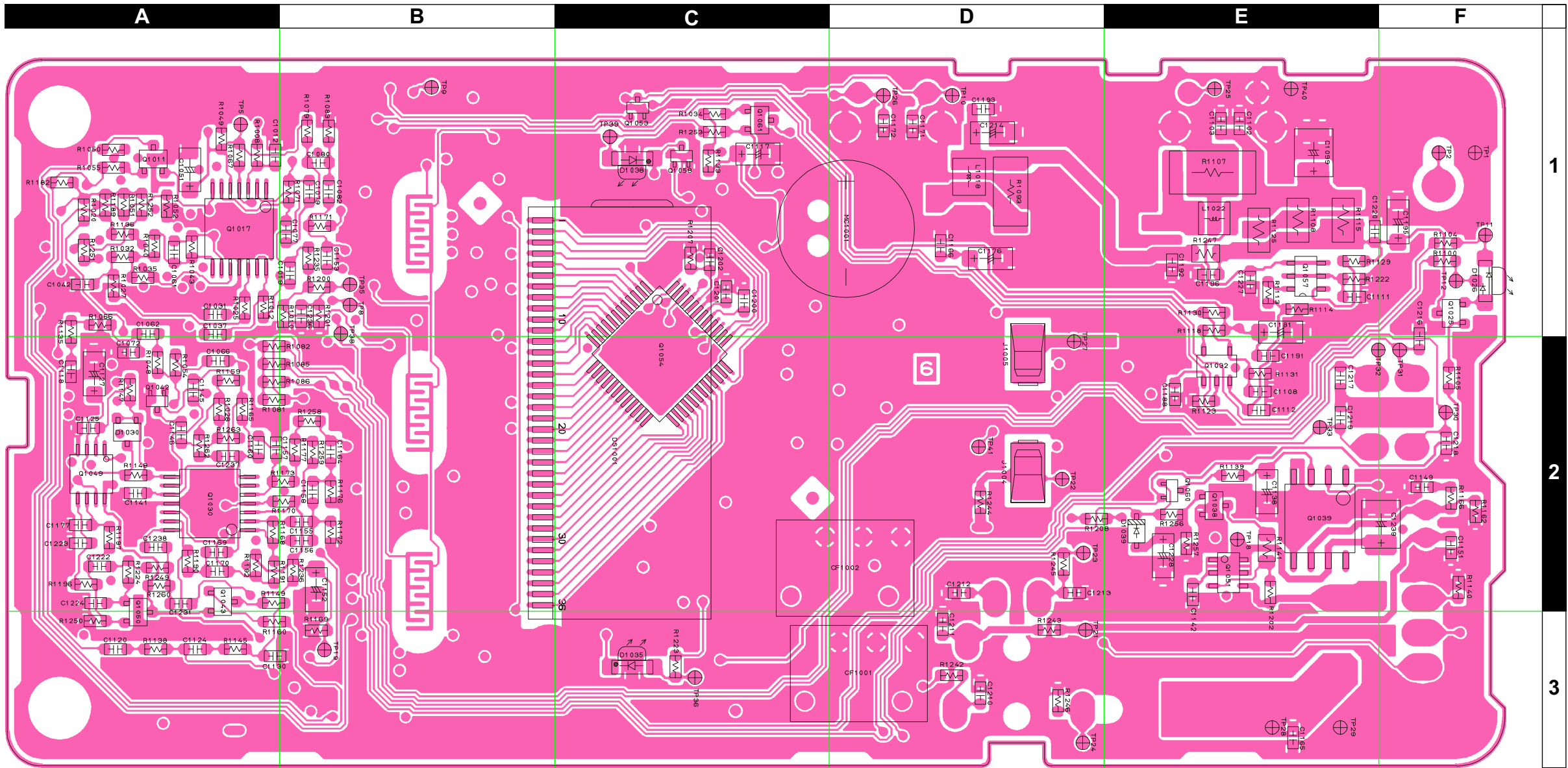

LC75834W (Q1054)

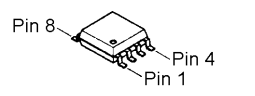

NJM12903R (Q1049)

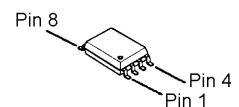

NJM2070M (Q1039)

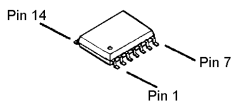

NJM2902V (Q1017, 1030)

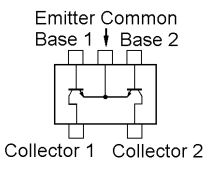

FMW1 (W1) (Q1032)

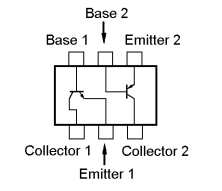

IMZ2 (Z2) (Q1057)

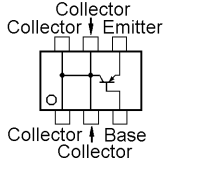

CPH6102 (AB) (Q1051)

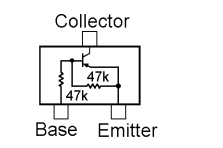

RT1P441U (P3) (Q1060)

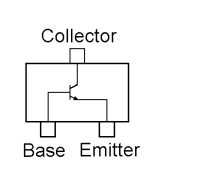

2SC4154E (LE) (Q1025, 1038, 1050, 1061)

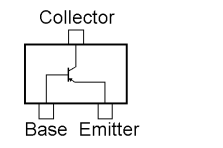

2SA1586Y (SY) (Q1011, 1043)

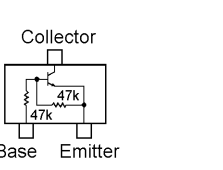

RT1N441U (N3) (Q1042, 1053)

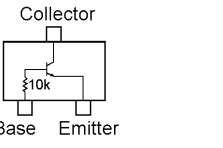

DTC124TE (05) (Q1058)

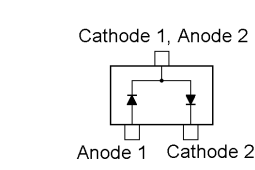

MC2850 (A7) (D1030)

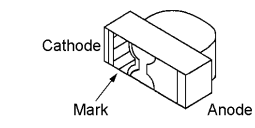

FA1101F (VX-180) (D1035, 1038)

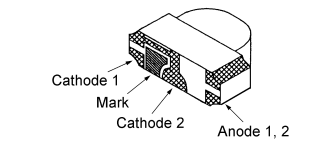

12-22SURSYGC/S530-A2/TR8 (D1026)

Parts Layout (Side B)

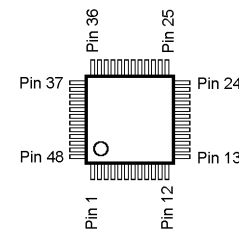
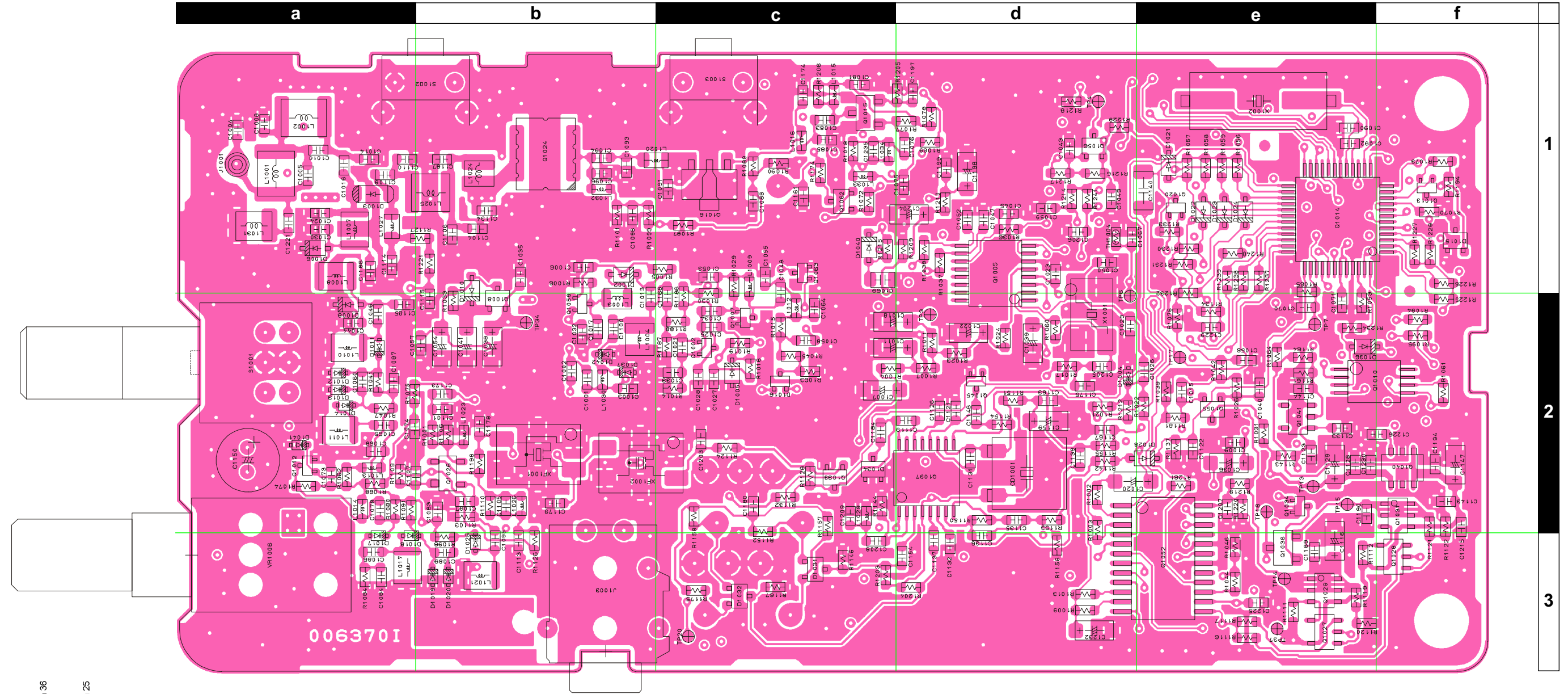

M37516M6 (Q1014)

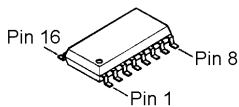

MB15A02PFV1 (Q1005)

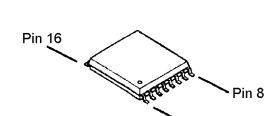

TA31136FN (Q1037)

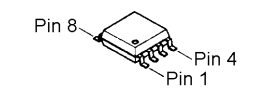

BR93L66FV (Q1010)

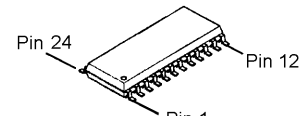

M62364FP (Q1052)

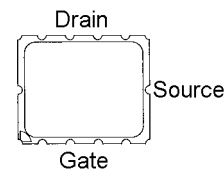

2SK2974 (Lot. 1-53)  
RD07MVS1 (Lot. 54-)  
(Q1024)

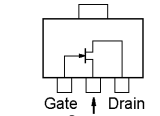

2SK2596 (BX) (Q1016)

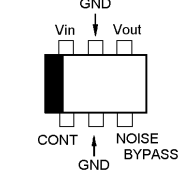

TK11250BMCL (Lot. 1-33)  
TK11250CMCL (Lot. 34-)  
(Q1040)

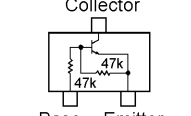

RT1N441U (N3)  
(Q1034, 1045, 1063)

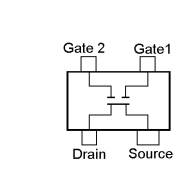

SGM2016AM (MA) (Q1026)

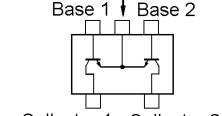

FMW1 (W1) (Q1027, 1028)

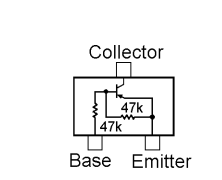

RT1P441U (P3) (Q1013, 1020, 1059)

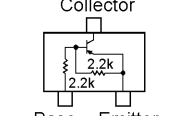

DTB123EK (F12) (Q1036)

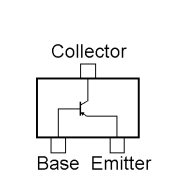

2SA1586Y (SY) (Q1056, 1062)

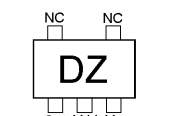

S-80735SN (DZ) (Lot. 1-27) (Q1041)

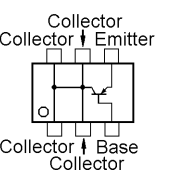

CPH6102 (AB) (Q1029, 1031)

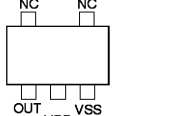

S-80835CNMC (Lot. 28-) (Q1041)



2SC4154E (LE) (Q1008, 1055)  
2SC5005 (73) (Q1007)  
2SC5006 (24) (Q1012)  
2SC4215Y (QY) (Q1033)  
2SC5227 (LN) (Q1015)  
2SC5231 (C8) (Q1002)

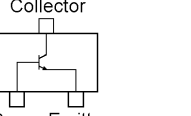

2SC4154E (LE) (Q1008, 1055)  
2SC5005 (73) (Q1007)  
2SC5006 (24) (Q1012)  
2SC4215Y (QY) (Q1033)  
2SC5227 (LN) (Q1015)  
2SC5231 (C8) (Q1002)

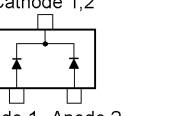

DAN235E (M) (D1016)

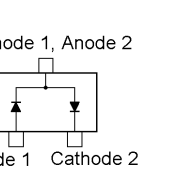

MC2850 (A7) (D1015, 1031, 1032, 1034)







Parts Layout

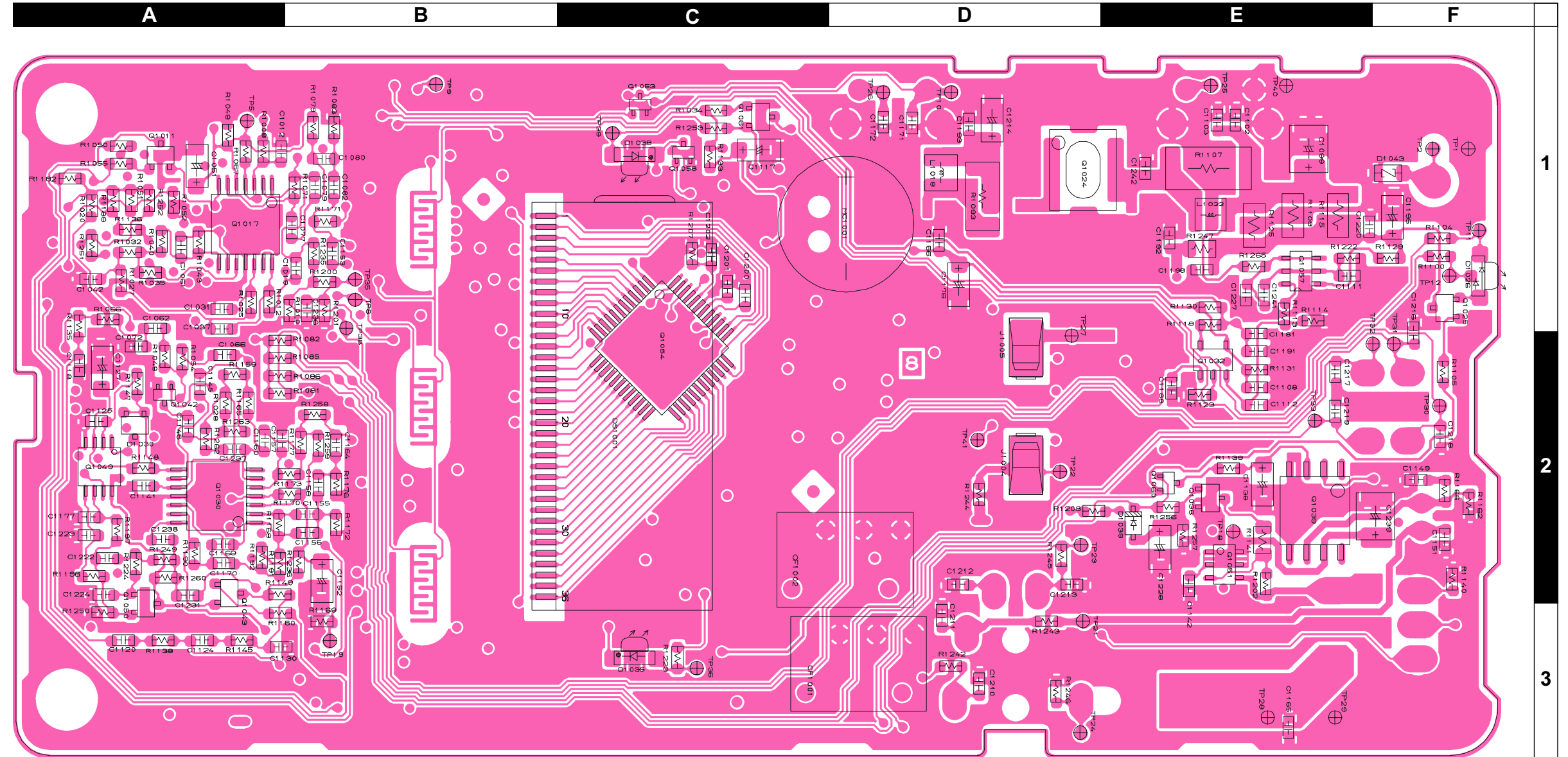

Side A

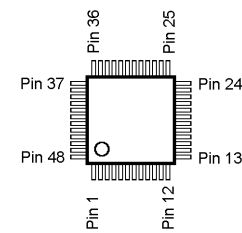

LC75834W (Q1054)

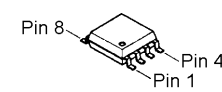

NJM12903R (Q1049)

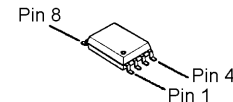

NJM2070M (Q1039)

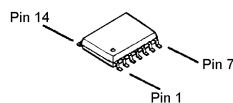

NJM2902V (Q1017, 1030)

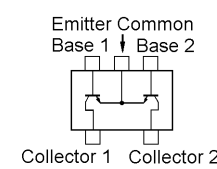

FMW1 (W1) (Q1032)

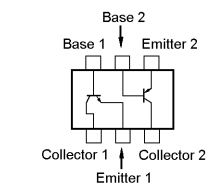

IMZ2 (Z2) (Q1057)

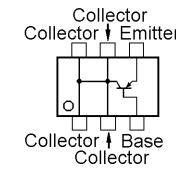

CPH6102 (AB) (Q1051)

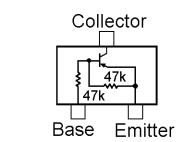

RT1P441U (P3) (Q1060)

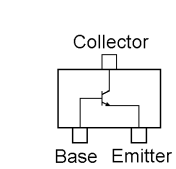

2SC4154E (LE) (Q1025, 1038, 1050, 1061)

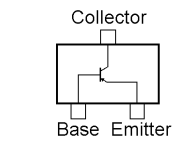

2SA1586Y (SY) (Q1011, 1043)

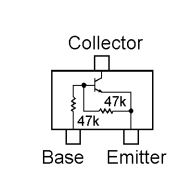

RT1N441U (N3) (Q1042, 1053)

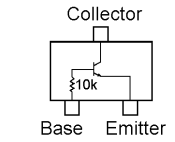

PDTOC114TE (24) (Q1058)

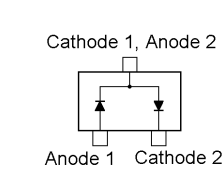

MC2850 (A7) (D1030)

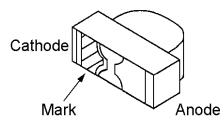

FA1101F (VX-180) (D1035, 1038)

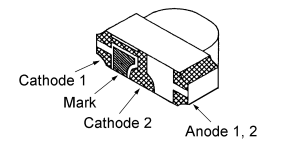

12-22SURYGC/S530-A2/TR8 (D1026)





Side B

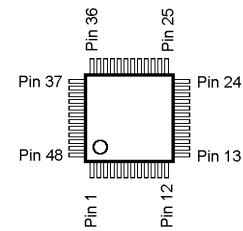

M37516E6HP (Q1014)

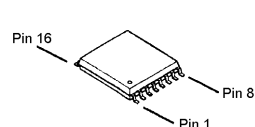

TA31136FN (Q1037)

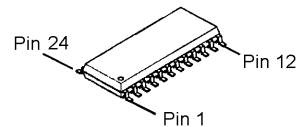

M62364FP (Q1052)

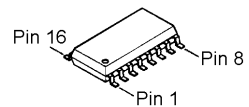

MB15A02PFV1 (Q1005)

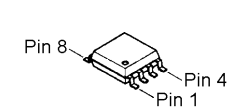

BR93LC66FV (Q1010)

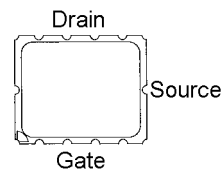

2SK2974 (Q1024)

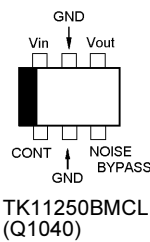

TK11250BMCL (Q1040)

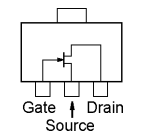

2SK2596 (BX) (Q1016)

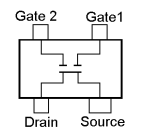

3SK299 (Q1026)

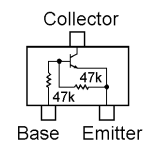

RT1N441U (N3) (Q1034, 1045, 1063)

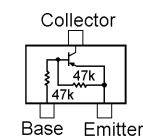

RT1P441U (P3) (Q1013, 1020, 1059)

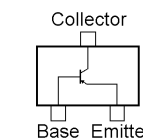

2SA1586Y (SY) (Q1056, 1062)

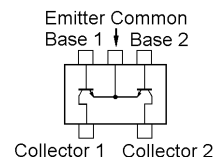

FMW1 (W1) (Q1027, 1028)

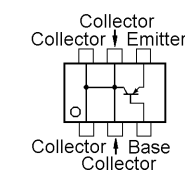

CPH6102 (AB) (Q1029, 1031)

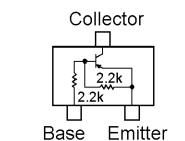

DTB123EK (F12) (Q1036)

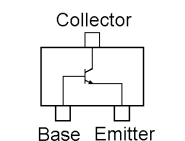

2SC4154E (LE) (Q1008, 1055)  
2SC5005 (73) (Q1007)  
2SC5006 (24) (Q1012)  
2SC4215Y (QY) (Q1033)  
2SC5227 (LN) (Q1015)

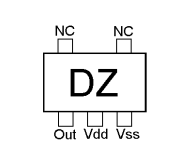

S-80735SN (DZ) (Q1041)

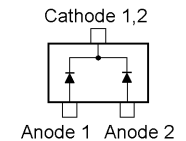

DAN235E (M) (D1014)

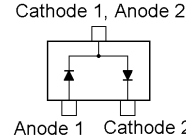

MC2850 (A7) (D1015, 1033, 1034, 1036)



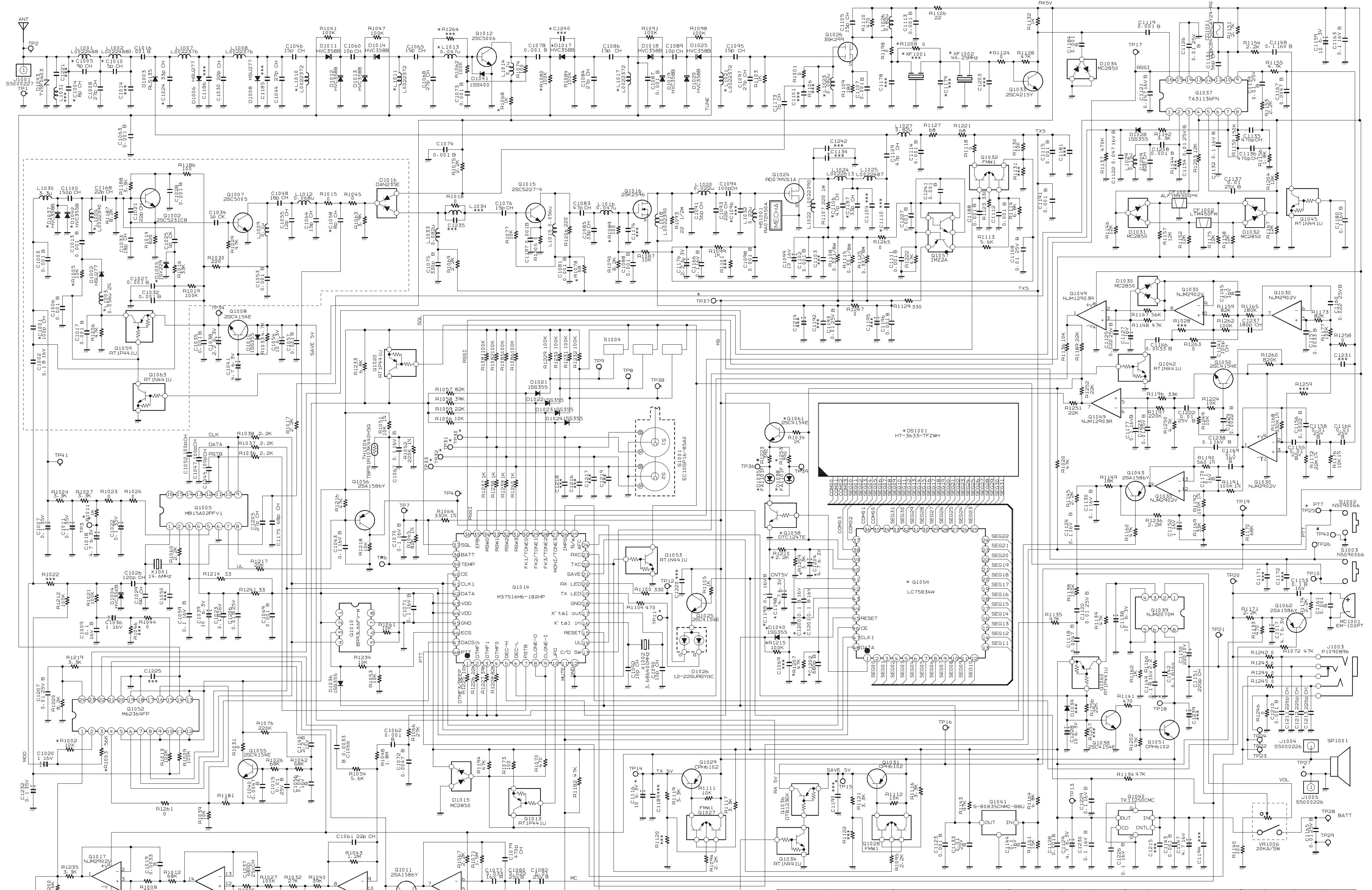

TYPE VALUE

C1001	100p	Type_C	150p	Type_CS1	100p	Type_A	C1187	33p	Type_C	50p	Type_CS1	30p	Type_A	L1017	L0022372	L0022372	L0022376	R1089	100	100	0	R1264	***	0Ω	***
C1004	8p	***	8p	***	10p	***	C1240	***	0.001μ	***	L1021	L0022372	L0022372	L0022376	R1124	0.5	390Ω	0.5	XF1001	***	H110235B	***			
C1005	8p	***	8p	***	10p	***	C1005	1S2294	HVC355B	1S2294	L1023	0.002μ	0.002μ	0.1μ	R1149	18k	18k	10k	XF1002	H1102346	H110235B	H1102346			
C1010	5p	***	5p	***	5p	***	C1017	HVC355B	***	***	L1017	HVC355B	***	10kΩ	5kΩ	5kΩ	4.7kΩ	R1149	18k	18k	10k	XF1001	***	H110235B	***
C1020	330	***	330	***	330	***	C1020	330	***	***	L1010	L0022372	L0022372	L0022376	R1103	50k	50k	50k							
C1058	8p	***	8p	***	8p	***	C1042	HVC355B	1S2294	HVC355B	R1005	10k	5k	5k											
C1098	***	***	***	***	***	***	C1003	0.056μ	0.047μ	0.056μ	R1011	1.0k	680Ω	1.0k											
C1201	***	***	***	***	***	***	C1054	100k	100k	100k	R1004	10k	10k	10k											
C1202	***	***	***	***	***	***	C1054	100k	100k	100k	R1004	10k	10k	10k											
C1204	***	***	***	***	***	***	C1054	100k	100k	100k	R1004	10k	10k	10k											
C1134	***	***	***	***	***	***	C1054	100k	100k	100k	R1004	10k	10k	10k											
C1035	***	***	***	***	***	***	C1054	100k	100k	100k	R1004	10k	10k	10k											



Parts Layout

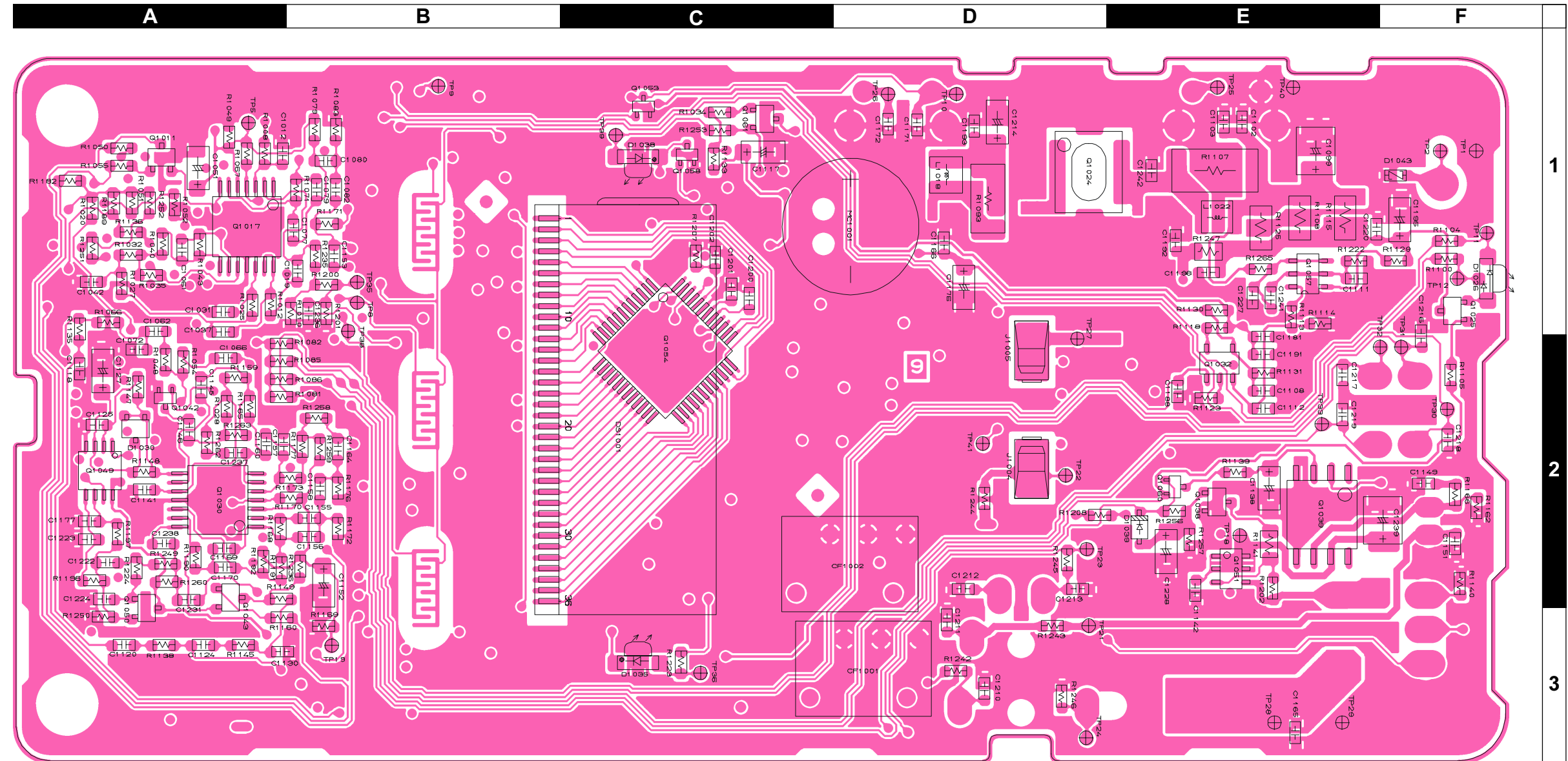

Side A

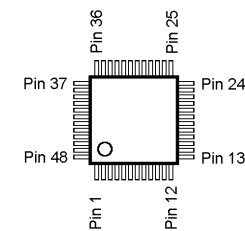

LC75834W (Q1054)

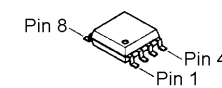

NJM12903R (Q1049)

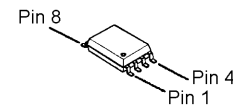

NJM2070M (Q1039)

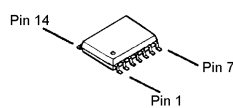

NJM2902V (Q1017, 1030)

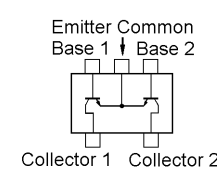

FMW1 (W1) (Q1032)

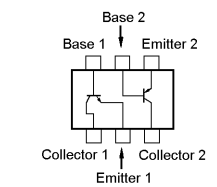

IMZ2 (Z2) (Q1057)

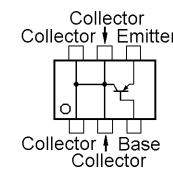

CPH6102 (AB) (Q1051)

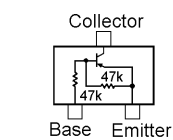

RT1P441U (P3) (Q1060)

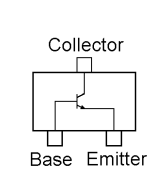

2SC4154E (LE) (Q1025, 1038, 1050, 1061)

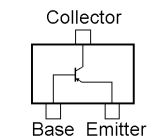

2SA1586Y (SY) (Q1011, 1043)

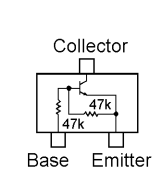

RT1N441U (N3) (Q1042, 1053)

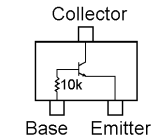

PDTCT114TE (24) (Q1058)

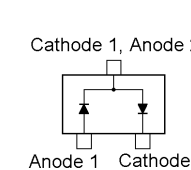

MC2850 (A7) (D1030)

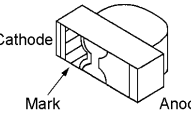

FA1101F (VX-180) (D1035, 1038)

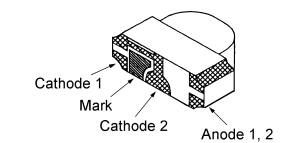

12-22SURSYGC/S530-A2/TR8 (D1026)





Side B

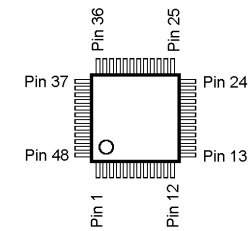

M37516E6HP (Q1014)

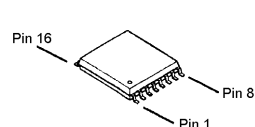

TA31136FN (Q1037)

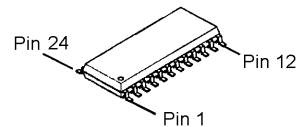

M62364FP (Q1052)

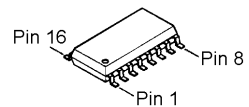

MB15A02PFV1 (Q1005)

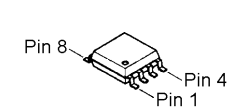

BR93LC66FV (Q1010)

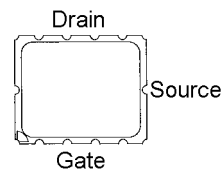

2SK2974 (Q1024)

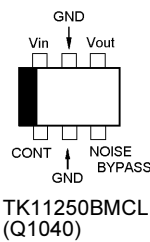

TK11250BMCL (Q1040)

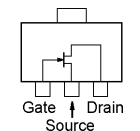

2SK2596 (BX) (Q1016)

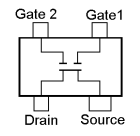

3SK299 (Q1026)

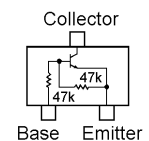

RT1N441U (N3) (Q1034, 1045, 1063)

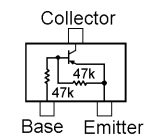

RT1P441U (P3) (Q1013, 1020, 1059)

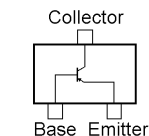

2SA1586Y (SY) (Q1056, 1062)

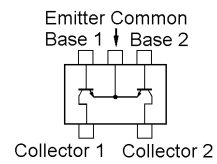

FMW1 (W1) (Q1027, 1028)

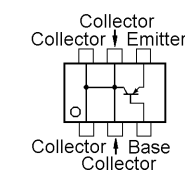

CPH6102 (AB) (Q1029, 1031)

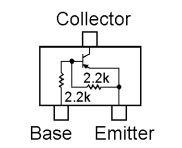

DTB123EK (F12) (Q1036)

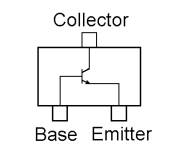

2SC4154E (LE) (Q1008, 1055)  
2SC5005 (73) (Q1007)  
2SC5006 (24) (Q1012)  
2SC4215Y (QY) (Q1033)  
2SC5227 (LN) (Q1015)

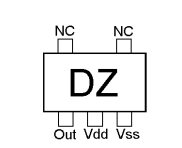

S-80735SN (DZ) (Q1041)

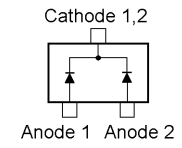

DAN235E (M) (D1014)

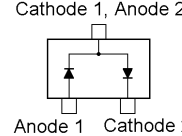

MC2850 (A7) (D1015, 1033, 1034, 1036)

Parts List

REF.	DESCRIPTION	VALUE	V/W	TOL.	MFR'S DESIG	VXSTD P/N	VERS.	LOT.	SIDE	LAY ADR
PCB with Components						CB1390003	VX-160 (EXP):TYP CS1			
						CB1390004	VX-180 (EXP):TYP CS1			
						CB1390007	VX-160 (VTX):TYP C			
						CB1390008	VX-160 (EXP):TYP C			
						CB1390009	VX-160 (VTX):TYP A			
						CB1390010	VX-160 (EXP):TYP A			
						CB1390013	VX-180 (VTX):TYP C			
						CB1390014	VX-180 (EXP):TYP C			
						CB1390015	VX-180 (VTX):TYP A			
						CB1390016	VX-180 (EXP):TYP A			
Printed Circuit Board						FR006370E		1-2		
						FR006370G		3-17		
						FR006370H		18-27		
						FR006370I		28-99		
						FR006370K		100-108		
						FR006370L		109-		
C 1001	CHIP CAP.	100pF	50V	CH	GRM1882C1H101JA01D	K22174235		1-31	B	b2
C 1001	CHIP CAP.	68pF	50V	CH	GRM1882C1H680JA01D	K22174231	TYP A	45-	B	b2
C 1001	CHIP CAP.	150pF	50V	CH	GRM1882C1H151JA01D	K22174239	TYP A	48	B	b2
C 1001	CHIP CAP.	68pF	50V	CH	GRM1882C1H680JA01D	K22174231	TYP A	49-	B	b2
C 1001	CHIP CAP.	100pF	50V	CH	GRM1882C1H101JA01D	K22174235	TYP A	100-	B	b2
C 1001	CHIP CAP.	100pF	50V	CH	GRM1882C1H101JA01D	K22174235	TYP C	32-	B	b2
C 1001	CHIP CAP.	68pF	50V	CH	GRM1882C1H680JA01D	K22174231	TYP CS1	32-	B	b2
C 1001	CHIP CAP.	47pF	50V	CH	GRM1882C1H470JA01D	K22174227	TYP CS1	39-	B	b2
C 1001	CHIP CAP.	82pF	50V	CH	GRM1882C1H820JA01D	K22174233	TYP CS1	54-	B	b2
C 1001	CHIP CAP.	150pF	50V	CH	GRM1882C1H151JA01D	K22174239	TYP CS1	100-	B	b2
C 1002	CHIP CAP.	0.1uF	16V	B	GRM188B11C104KA01D	K22124805		1-	B	b2
C 1003	CHIP CAP.	0.001uF	50V	B	GRM188B11H102KA01D	K22174821		1-	B	b2
C 1004	CHIP CAP.	8pF	50V	CH	GRM1882C1H8R0DZ01D	K22174209		1-44	B	a1
C 1004	CHIP CAP.	12pF	50V	CH	GRM1882C1H120JA01D	K22174213	TYP A	45-	B	a1
C 1004	CHIP CAP.	8pF	50V	CH	GRM1882C1H8R0DZ01D	K22174209	TYP C	45-	B	a1
C 1004	CHIP CAP.	8pF	50V	CH	GRM1882C1H8R0DZ01D	K22174209	TYP CS1	45-	B	a1
C 1005	CHIP CAP.	8pF	50V	CH	GRM1882C1H8R0DZ01D	K22174209		1-38	B	a1
C 1005	CHIP CAP.	10pF	50V	CH	GRM1882C1H100JA01D	K22174211	TYP A	39-	B	a1
C 1005	CHIP CAP.	8pF	50V	CH	GRM1882C1H8R0DZ01D	K22174209	TYP C	39-	B	a1
C 1005	CHIP CAP.	8pF	50V	CH	GRM1882C1H8R0DZ01D	K22174209	TYP C	50-	B	a1
C 1005	CHIP CAP.	9pF	50V	CH	GRM1882C1H9R0DZ01D	K22174210	TYP C	54-	B	a1
C 1005	CHIP CAP.	9pF	50V	CH	GRM1882C1H9R0DZ01D	K22174210	TYP CS1	39-	B	a1
C 1006	CHIP CAP.	0.001uF	50V	B	GRM188B11H102KA01D	K22174821		1-	B	b1
C 1007	CHIP TA.CAP.	0.1uF	35V		TESVA1V104M1-8R	K78160025		1-	B	c2
C 1008	CHIP CAP.	22pF	50V	CH	GRM1882C1H220JA01D	K22174219		1-44	B	a1
C 1008	CHIP CAP.	27pF	50V	CH	GRM1882C1H270JA01D	K22174221	TYP A	45-	B	a1
C 1008	CHIP CAP.	27pF	50V	CH	GRM1882C1H270JA01D	K22174221	TYP A	50-53	B	a1
C 1008	CHIP CAP.	22pF	50V	CH	GRM1882C1H220JA01D	K22174219	TYP C	45-	B	a1
C 1008	CHIP CAP.	22pF	50V	CH	GRM1882C1H220JA01D	K22174219	TYP C	50-53	B	a1
C 1008	CHIP CAP.	22pF	50V	CH	GRM1882C1H220JA01D	K22174219	TYP CS1	45-	B	a1
C 1008	CHIP CAP.	22pF	50V	CH	GRM1882C1H220JA01D	K22174219	TYP CS1	50-53	B	a1
C 1008	CHIP CAP.	27pF	50V	CH	GRM1882C1H270JA01D	K22174221		54-	B	a1
C 1009	CHIP CAP.	0.1uF	16V	B	GRM188B11C104KA01D	K22124805		1-	B	e2
C 1010	CHIP CAP.	5pF	50V	CH	GRM1882C1H5R0CZ01D	K22174206		1-38	B	a1
C 1010	CHIP CAP.	5pF	50V	CH	GRM1882C1H5R0CZ01D	K22174206	TYP A	39-	B	a1
C 1010	CHIP CAP.	5pF	50V	CH	GRM1882C1H5R0CZ01D	K22174206	TYP C	39-	B	a1
C 1010	CHIP CAP.	6pF	50V	CH	GRM1882C1H6R0DZ01D	K22174207	TYP CS1	39-	B	a1
C 1011	CHIP TA.CAP.	0.1uF	35V		TESVA1V104M1-8R	K78160025		1-	B	c2
C 1012	CHIP CAP.	150pF	50V	CH	GRM1882C1H151JA01D	K22174239		1-	A	A1
C 1013	CHIP CAP.	0.001uF	50V	B	GRM188B11H102KA01D	K22174821		1-	B	b2
C 1015	CHIP CAP.	0.01uF	25V	B	GRM39B103K25PT	K22144803		1-	B	e2
C 1016	CHIP CAP.	0.001uF	50V	B	GRM188B11H102KA01D	K22174821		1-	B	a1
C 1017	CHIP CAP.	0.001uF	50V	B	GRM188B11H102KA01D	K22174821		1-	B	b2
C 1018	CHIP TA.CAP.	4.7uF	6.3V		TEMSVA0J475M-8R	K78080017		1-	B	c2
C 1019	CHIP CAP.	0.0033uF	50V	B	GRM188B11H332KA01D	K22174831		1-	A	B1
C 1020	CHIP TA.CAP.	1uF	16V		TESVA1C105M1-8R	K78120009		1-	B	d2
C 1021	CHIP CAP.	22pF	50V	CH	GRM1552C1H220JZ01D	K22178220		1-	B	c2
C 1021	CHIP CAP.	22pF	50V	CH	GRM1882C1H220JA01D	K22174219		107-	B	c2

# MAIN Unit

REF.	DESCRIPTION	VALUE	V/W	TOL.	MFR'S DESIG	VXSTD P/N	VERS.	LOT.	SIDE	LAY ADR
C 1022	CHIP TA.CAP.	0.1uF	35V		TESVA1V104M1-8R	K78160025		1-	B	d2
C 1023	CHIP CAP.	0.1uF	16V	B	GRM188B11C104KA01D	K22124805		1-	B	d1
C 1024	CHIP CAP.	27pF	50V	CH	GRM1882C1H270JA01D	K22174221		1-	B	a1
C 1024	CHIP CAP.	27pF	50V	CH	GRM1882C1H270JA01D	K22174221		50-53	B	a1
C 1024	CHIP CAP.	27pF	50V	CH	GRM1882C1H270JA01D	K22174221	TYP A	54-	B	a1
C 1024	CHIP CAP.	33pF	50V	CH	GRM1882C1H330JA01D	K22174223	TYP C	54-	B	a1
C 1024	CHIP CAP.	33pF	50V	CH	GRM1882C1H330JA01D	K22174223	TYP CS1	54-	B	a1
C 1025	CHIP CAP.	2pF	50V	CK	GRM1884C1H2R0CZ01D	K22174203		1-44	B	c2
C 1025	CHIP CAP.	1pF	50V	CK	GRM1884C1H1R0CZ01D	K22174202	TYP A	45-	B	c2
C 1025	CHIP CAP.	1pF	50V	CK	GRM1884C1H1R0BZ01D	K22174267	TYP A	49-99	B	c2
C 1025	CHIP CAP.	2pF	50V	CK	GRM1884C1H2R0CZ01D	K22174203	TYP C	45-99	B	c2
C 1025	CHIP CAP.	2pF	50V	CK	GRM1884C1H2R0CZ01D	K22174203	TYP CS1	45-99	B	c2
C 1025	CHIP CAP.	1pF	50V	CK	GRM1884C1H1R0BZ01D	K22174267		100-	B	c2
C 1026	CHIP CAP.	120pF	50V	CH	GRM1882C1H121JA01D	K22174237		1-	B	e2
C 1027	CHIP CAP.	0.001uF	50V	B	GRM188B11H102KA01D	K22174821		1-	B	c2
C 1028	CHIP CAP.	0.001uF	50V	B	GRM188B11H102KA01D	K22174821		1-	B	c2
C 1029	CHIP CAP.	6pF	50V	CH	GRM1882C1H6R0DZ01D	K22174207		1-	B	d2
C 1030	CHIP CAP.	22pF	50V	CH	GRM1882C1H220JA01D	K22174219		1-	B	a1
C 1031	CHIP CAP.	470pF	50V	CH	GRM1882C1H471JA01D	K22174249		1-	A	A1
C 1032	CHIP CAP.	0.001uF	50V	B	GRM188B11H102KA01D	K22174821		1-	B	b2
C 1033	CHIP CAP.	18pF	50V	CH		K22174217		1-	B	c2
C 1034	CHIP CAP.	3pF	50V	CJ	GRM1883C1H3R0CZ01D	K22174204		1-	B	c2
C 1034	CHIP CAP.	1pF	50V	CK	GRM1884C1H1R0CZ01D	K22174202		28-	B	c2
C 1035	CHIP CAP.	0.001uF	50V	B	GRM188B11H102KA01D	K22174821		1-	B	b1
C 1036	CHIP TA.CAP.	1uF	16V		TESVA1C105M1-8R	K78120009		1-	B	e2
C 1037	CHIP CAP.	680pF	25V	CH	GRM39CH681J25PT	K22144203		1-	A	A2
C 1038	CHIP TA.CAP.	2.2uF	6.3V		TESVA0J225M1-8R	K78080009		1-	B	b2
C 1039	CHIP TA.CAP.	10uF	6.3V		TEMSVA0J106M-8R	K78080027		1-	B	d2
C 1040	CHIP CAP.	0.0047uF	50V	B	GRM188B11H472KA01D	K22174833		1-	B	e2
C 1041	CHIP TA.CAP.	4.7uF	6.3V		TEMSVA0J475M-8R	K78080017		1-	B	b2
C 1042	CHIP CAP.	0.001uF	50V	B	GRM188B11H102KA01D	K22174821		1-	A	A1
C 1043	CHIP CAP.	0.1uF	16V	B	GRM188B11C104KA01D	K22124805		1-	B	d1
C 1044	CHIP CAP.	27pF	50V	CH	GRM1882C1H270JA01D	K22174221		1-	B	a2
C 1045	CHIP CAP.	100pF	50V	CH	GRM1882C1H101JA01D	K22174235		1-	B	d1
C 1046	CHIP CAP.	15pF	50V	CH	GRM1882C1H150JA01D	K22174215		1-	B	a2
C 1047	CHIP CAP.	100pF	50V	CH	GRM1882C1H101JA01D	K22174235		1-	B	d1
C 1048	CHIP CAP.	18pF	50V	CH		K22174217		1-	B	c1
C 1049	CHIP CAP.	0.001uF	50V	B	GRM188B11H102KA01D	K22174821		1-	B	d1
C 1051	CHIP TA.CAP.	10uF	6.3V		TEMSVA0J106M-8R	K78080027		1-	A	A1
C 1052	CHIP CAP.	100pF	50V	CH	GRM1882C1H101JA01D	K22174235		1-	B	d1
C 1053	CHIP CAP.	0.001uF	50V	B	GRM188B11H102KA01D	K22174821		1-	B	c1
C 1054	CHIP TA.CAP.	10uF	6.3V		TEMSVA0J106M-8R	K78080027		1-	B	b2
C 1055	CHIP CAP.	12pF	50V	CH	GRM1882C1H120JA01D	K22174213		1-	B	c1
C 1056	CHIP CAP.	0.047uF	16V	B	GRM39B473K16PT	K22124804		1-	B	e2
C 1057	CHIP CAP.	0.001uF	50V	B	GRM188B11H102KA01D	K22174821		1-	B	b2
C 1058	CHIP CAP.	5pF	50V	CH	GRM1882C1H5R0CZ01D	K22174206		1-	B	c2
C 1058	CHIP CAP.	8pF	50V	CH	GRM1882C1H8R0DZ01D	K22174209		28-31	B	c2
C 1058	CHIP CAP.	8pF	50V	CH	GRM1882C1H8R0DZ01D	K22174209	TYP A	45-	B	c2
C 1058	CHIP CAP.	8pF	50V	CH	GRM1882C1H8R0DZ01D	K22174209	TYP C	32-	B	c2
C 1058	CHIP CAP.	22pF	50V	CH	GRM1882C1H220JA01D	K22174219	TYP CS1	32-	B	c2
C 1059	CHIP CAP.	0.1uF	16V	B	GRM188B11C104KA01D	K22124805		1-	B	d1
C 1060	CHIP CAP.	10pF	50V	CH	GRM1882C1H100JA01D	K22174211		1-	B	a2
C 1061	CHIP CAP.	22pF	50V	CH	GRM1882C1H220JA01D	K22174219		1-	A	A1
C 1062	CHIP CAP.	0.001uF	50V	B	GRM188B11H102KA01D	K22174821		1-	A	A1
C 1063	CHIP CAP.	0.001uF	50V	B	GRM188B11H102KA01D	K22174821		1-	B	b2
C 1064	CHIP CAP.	15pF	50V	CH	GRM1882C1H150JA01D	K22174215		1-	B	c2
C 1065	CHIP CAP.	15pF	50V	CH	GRM1882C1H150JA01D	K22174215		1-	B	a2
C 1066	CHIP CAP.	0.0033uF	50V	B	GRM188B11H332KA01D	K22174831		1-	A	A2
C 1067	CHIP CAP.	0.1uF	16V	B	GRM188B11C104KA01D	K22124805		1-	B	d1
C 1068	CHIP CAP.	27pF	50V	CH	GRM1882C1H270JA01D	K22174221		1-	B	a2
C 1070	CHIP CAP.	0.1uF	16V	B	GRM188B11C104KA01D	K22124805		1-	B	e2
C 1071	CHIP CAP.	0.1uF	16V	B	GRM188B11C104KA01D	K22124805		1-	B	e2
C 1072	CHIP CAP.	0.0047uF	50V	B	GRM188B11H472KA01D	K22174833		1-	A	A2
C 1073	CHIP CAP.	0.001uF	50V	B	GRM188B11H102KA01D	K22174821		1-	B	a2

REF.	DESCRIPTION	VALUE	V/W	TOL.	MFR'S DESIG	VXSTD P/N	VERS.	LOT.	SIDE	LAY ADR
C 1074	CHIP CAP.	0.001uF	50V	B	GRM188B11H102KA01D	K22174821		1-	B	a2
C 1075	CHIP CAP.	330pF	50V	B	GRM188B11H331KD01D	K22174820		1-	B	d1
C 1076	CHIP CAP.	15pF	50V	CH	GRM1882C1H150JA01D	K22174215		1-	B	d1
C 1077	CHIP CAP.	0.033uF	16V	R	GRM188R11C333KA01D	K22124801		1-	A	B1
C 1078	CHIP CAP.	0.001uF	50V	B	GRM188B11H102KA01D	K22174821		1-	B	a2
C 1079	CHIP CAP.	470pF	50V	CH	GRM1882C1H471JA01D	K22174249		1-	A	B1
C 1080	CHIP CAP.	0.022uF	25V	B	GRM39B223K25PT	K22144807		1-	A	B1
C 1081	CHIP CAP.	0.001uF	50V	B	GRM188B11H102KA01D	K22174821		1-	B	c1
C 1082	CHIP CAP.	0.01uF	25V	B	GRM39B103K25PT	K22144803		1-	A	B1
C 1083	CHIP CAP.	47pF	50V	CH	GRM1882C1H470JA01D	K22174227		1-	B	c1
C 1084	CHIP CAP.	27pF	50V	CH	GRM1882C1H270JA01D	K22174221		1-	B	a3
C 1085	CHIP CAP.	33pF	50V	CH	GRM1882C1H330JA01D	K22174223		1-	B	c1
C 1086	CHIP CAP.	15pF	50V	CH	GRM1882C1H150JA01D	K22174215		1-	B	a3
C 1087	CHIP CAP.	0.001uF	50V	B	GRM188B11H102KA01D	K22174821		1-	B	a2
C 1088	CHIP CAP.	0.001uF	50V	B	GRM188B11H102KA01D	K22174821		1-	B	c1
C 1089	CHIP CAP.	10pF	50V	CH	GRM1882C1H100JA01D	K22174211		1-	B	b3
C 1090	CHIP CAP.	10pF	50V	CH	GRM1882C1H100JA01D	K22174211		1-	B	e1
C 1091	CHIP CAP.	56pF	50V	CH	GRM1882C1H560JA01D	K22174229		1-	B	c1
C 1092	CHIP CAP.	10pF	50V	CH	GRM1882C1H100JA01D	K22174211		1-	B	e1
C 1093	CHIP CAP.	22pF	50V	CH	GRM1882C1H220JA01D	K22174219		1-	B	b1
C 1094	CHIP CAP.	47pF	50V	CH	GRM1882C1H470JA01D	K22174227		1-	B	b1
C 1094	CHIP CAP.	47pF	50V	CH	GRM1882C1H470JA01D	K22174227		50-	B	b1
C 1094	CHIP CAP.	100pF	50V	CH	GRM1882C1H101JA01D	K22174235		54-	B	b1
C 1095	CHIP CAP.	15pF	50V	CH	GRM1882C1H150JA01D	K22174215		1-	B	b3
C 1096	CHIP CAP.	22pF	50V	CH	GRM1882C1H220JA01D	K22174219	TYP CS1	39-	B	b1
C 1097	CHIP CAP.	27pF	50V	CH	GRM1882C1H270JA01D	K22174221		1-	B	b2
C 1098	CHIP CAP.	0.001uF	50V	B	GRM188B11H102KA01D	K22174821		1-	B	b1
C 1099	CHIP TA.CAP.	10uF	16V		TEMSVB21C106M-8R	K78120025		1-	A	E1
C 1100	CHIP CAP.	150pF	50V	CH	GRM1882C1H151JA01D	K22174239		1-	B	b2
C 1102	CHIP CAP.	0.001uF	50V	B	GRM188B11H102KA01D	K22174821		1-	A	E1
C 1105	CHIP CAP.	15pF	50V	CH	GRM1882C1H150JA01D	K22174215		1-	B	b2
C 1106	CHIP CAP.	47pF	50V	CH	GRM1882C1H470JA01D	K22174227		1-44	B	b1
C 1106	CHIP CAP.	56pF	50V	CH	GRM1882C1H560JA01D	K22174229	TYP A	45-	B	b1
C 1106	CHIP CAP.	47pF	50V	CH	GRM1882C1H470JA01D	K22174227	TYP C	45-	B	b1
C 1106	CHIP CAP.	47pF	50V	CH	GRM1882C1H470JA01D	K22174227	TYP CS1	45-	B	b1
C 1107	CHIP CAP.	0.001uF	50V	B	GRM188B11H102KA01D	K22174821		1-	B	a2
C 1108	CHIP CAP.	0.01uF	25V	B	GRM39B103K25PT	K22144803		1-	A	E2
C 1109	CHIP CAP.	47pF	50V	CH	GRM1882C1H470JA01D	K22174227		1-	B	a1
C 1110	CHIP CAP.	5pF	50V	CH	GRM1882C1H5R0CZ01D	K22174206		1-44	B	a1
C 1110	CHIP CAP.	8pF	50V	CH	GRM1882C1H8R0DZ01D	K22174209	TYP A	45-	B	a1
C 1110	CHIP CAP.	8pF	50V	CH	GRM1882C1H8R0DZ01D	K22174209	TYP A	50-	B	a1
C 1110	CHIP CAP.	10pF	50V	CH	GRM1882C1H100JA01D	K22174211	TYP A	54-	B	a1
C 1110	CHIP CAP.	12pF	50V	CH	GRM1882C1H120JA01D	K22174213	TYP A	80-	B	a1
C 1110	CHIP CAP.	7pF	50V	CH	GRM1882C1H7R0DZ01D	K22174208	TYP A	103-	B	a1
C 1110	CHIP CAP.	5pF	50V	CH	GRM1882C1H5R0CZ01D	K22174206	TYP C	45-	B	a1
C 1110	CHIP CAP.	5pF	50V	CH	GRM1882C1H5R0CZ01D	K22174206	TYP C	50-	B	a1
C 1110	CHIP CAP.	7pF	50V	CH	GRM1882C1H7R0DZ01D	K22174208	TYP C	54-99	B	a1
C 1110	CHIP CAP.	5pF	50V	CH	GRM1882C1H5R0CZ01D	K22174206	TYP CS1	45-	B	a1
C 1110	CHIP CAP.	5pF	50V	CH	GRM1882C1H5R0CZ01D	K22174206	TYP CS1	50-	B	a1
C 1110	CHIP CAP.	7pF	50V	CH	GRM1882C1H7R0DZ01D	K22174208	TYP CS1	54-99	B	a1
C 1111	CHIP CAP.	0.001uF	50V	B	GRM188B11H102KA01D	K22174821		1-	A	E1
C 1112	CHIP CAP.	0.001uF	50V	B	GRM188B11H102KA01D	K22174821		1-	A	E2
C 1113	CHIP CAP.	0.001uF	50V	B	GRM188B11H102KA01D	K22174821		1-	B	b3
C 1114	CHIP CAP.	0.001uF	50V	B	GRM188B11H102KA01D	K22174821		1-	B	a1
C 1115	CHIP CAP.	0.001uF	50V	B	GRM188B11H102KA01D	K22174821		1-	B	b2
C 1116	CHIP TA.CAP.	10uF	6.3V		TEMSVA0J106M-8R	K78080027		1-	B	e3
C 1117	CHIP TA.CAP.	4.7uF	6.3V		TEMSVA0J475M-8R	K78080017		1-	A	C1
C 1118	CHIP CAP.	0.0047uF	50V	B	GRM188B11H472KA01D	K22174833		1-	A	A2
C 1119	CHIP CAP.	0.001uF	50V	B	GRM188B11H102KA01D	K22174821		1-	B	d2
C 1120	CHIP CAP.	0.01uF	25V	B	GRM39B103K25PT	K22144803		1-	A	A3
C 1121	CHIP CAP.	0.047uF	16V	B	GRM39B473K16PT	K22124804		1-	B	d2
C 1122	CHIP CAP.	0.047uF	16V	B	GRM39B473K16PT	K22124804		1-	B	e2
C 1122	CHIP CAP.	0.047uF	16V	B	GRM39B473K16PT	K22124804		54-	B	e2
C 1123	CHIP CAP.	0.001uF	50V	B	GRM188B11H102KA01D	K22174821		1-	B	e2

# MAIN Unit

REF.	DESCRIPTION	VALUE	V/W	TOL.	MFR'S DESIG	VXSTD P/N	VERS.	LOT.	SIDE	LAY ADR
C 1124	CHIP CAP.	0.1uF	16V	B	GRM188B11C104KA01D	K22124805		1-	A	A3
C 1125	CHIP CAP.	0.01uF	25V	B	GRM39B103K25PT	K22144803		1-	A	A2
C 1125	CHIP CAP.	0.022uF	25V	B	GRM39B223K25PT	K22144807		18-	A	A2
C 1126	CHIP CAP.	0.01uF	25V	B	GRM39B103K25PT	K22144803		1-	B	d2
C 1126	CHIP CAP.	0.01uF	25V	B	GRM39B103K25PT	K22144803		54-	B	d2
C 1127	CHIP TA.CAP.	1uF	16V		TESVA1C105M1-8R	K78120009		1-	A	A2
C 1128	CHIP CAP.	0.001uF	50V	B	GRM188B11H102KA01D	K22174821		1-	B	e2
C 1129	CHIP TA.CAP.	4.7uF	6.3V		TEMSVA0J475M-8R	K78080017		1-	B	e2
C 1130	CHIP CAP.	0.1uF	16V	B	GRM188B11C104KA01D	K22124805		1-	A	A3
C 1131	CHIP CAP.	56pF	50V	CH	GRM1882C1H560JA01D	K22174229		1-	B	d2
C 1132	CHIP CAP.	0.1uF	16V	B	GRM188B11C104KA01D	K22124805		1-	B	d3
C 1133	CHIP CAP.	0.01uF	25V	B	GRM39B103K25PT	K22144803		1-	B	e2
C 1134	CHIP CAP.	27pF	50V	CH	GRM1882C1H270JA01D	K22174221		1-	B	b1
C 1134	CHIP CAP.	27pF	50V	CH	GRM1882C1H270JA01D	K22174221		50-53	B	b1
C 1134	CHIP CAP.	27pF	50V	CH	GRM1882C1H270JA01D	K22174221	TYP A	54-	B	b1
C 1135	CHIP CAP.	470pF	50V	CH	GRM1882C1H471JA01D	K22174249		1-	B	d2
C 1135	CHIP CAP.	470pF	50V	CH	GRM1882C1H471JA01D	K22174249		54-	B	d2
C 1136	CHIP CAP.	470pF	50V	CH	GRM1882C1H471JA01D	K22174249		1-	B	d3
C 1136	CHIP CAP.	470pF	50V	CH	GRM1882C1H471JA01D	K22174249		54-	B	d3
C 1137	CHIP CAP.	0.01uF	25V	B	GRM39B103K25PT	K22144803		1-	B	d3
C 1138	CHIP TA.CAP.	10uF	6.3V		TEMSVA0J106M-8R	K78080027		1-	A	E2
C 1139	CHIP CAP.	0.01uF	25V	B	GRM39B103K25PT	K22144803		1-	B	d2
C 1139	CHIP CAP.	0.01uF	25V	B	GRM39B103K25PT	K22144803		54-	B	d2
C 1140	CHIP CAP.	2.2uF	10V	B	GRM42-6B225K10PT	K22101801		18-	B	e1
C 1140	CHIP CAP.	2.2uF	10V	B	GRM188B31A225KE18D	K22104805		100-	B	e1
C 1141	CHIP CAP.	0.001uF	50V	B	GRM188B11H102KA01D	K22174821		1-	A	A2
C 1141	CHIP CAP.	100pF	50V	CH	GRM1882C1H101JA01D	K22174235		18-	A	A2
C 1142	CHIP CAP.	0.1uF	16V	B	GRM188B11C104KA01D	K22124805		1-	A	E2
C 1143	CHIP CAP.	0.001uF	50V	B	GRM188B11H102KA01D	K22174821		1-	B	f2
C 1144	CHIP CAP.	0.022uF	25V	B	GRM39B223K25PT	K22144807		1-	B	e2
C 1144	CHIP CAP.	0.1uF	16V	B	GRM188B11C104KA01D	K22124805		18-	B	e2
C 1145	CHIP CAP.	0.022uF	25V	B	GRM39B223K25PT	K22144807		1-	A	A2
C 1145	CHIP CAP.	0.1uF	16V	B	GRM188B11C104KA01D	K22124805		18-	A	A2
C 1146	CHIP CAP.	0.0033uF	50V	B	GRM188B11H332KA01D	K22174831		1-	A	A2
C 1147	CHIP TA.CAP.	4.7uF	16V		TEMSVA1C475M-8R	K78120031		1-	B	f2
C 1148	CHIP CAP.	0.1uF	16V	B	GRM188B11C104KA01D	K22124805		1-	B	d2
C 1149	CHIP CAP.	0.1uF	16V	B	GRM188B11C104KA01D	K22124805		1-	A	F2
C 1150	AL.ELECTRO.CAP.	220uF	10V		ESMG100ELL221ME11S	K40109027		1-	B	a2
C 1151	CHIP CAP.	220pF	50V	CH	GRM1882C1H221JA01D	K22174243		1-	A	F2
C 1152	CHIP TA.CAP.	1uF	16V		TESVA1C105M1-8R	K78120009		1-	A	B2
C 1153	CHIP CAP.	0.1uF	16V	B	GRM188B11C104KA01D	K22124805		1-	A	B1
C 1154	CHIP CAP.	0.01uF	25V	B	GRM39B103K25PT	K22144803		1-	B	d3
C 1155	CHIP CAP.	0.01uF	25V	B	GRM39B103K25PT	K22144803		1-	A	B2
C 1156	CHIP CAP.	0.0022uF	50V	B	GRM188B11H222KA01D	K22174822		1-	A	B2
C 1157	CHIP CAP.	0.0047uF	50V	B	GRM188B11H472KA01D	K22174833		1-	A	A2
C 1157	CHIP CAP.	0.0033uF	50V	B	GRM188B11H332KA01D	K22174831		18-	A	A2
C 1158	CHIP CAP.	0.01uF	25V	B	GRM39B103K25PT	K22144803		1-	A	B2
C 1159	CHIP TA.CAP.	10uF	6.3V		TEMSVA0J106M-8R	K78080027		1-	B	d2
C 1160	CHIP CAP.	0.01uF	25V	B	GRM39B103K25PT	K22144803		1-	A	A2
C 1160	CHIP CAP.	0.022uF	25V	B	GRM39B223K25PT	K22144807		18-	A	A2
C 1161	CHIP CAP.	0.001uF	50V	B	GRM188B11H102KA01D	K22174821		1-	B	c1
C 1163	CHIP CAP.	0.1uF	16V	B	GRM188B11C104KA01D	K22124805		1-	B	d2
C 1164	CHIP CAP.	0.01uF	25V	B	GRM39B103K25PT	K22144803		1-	A	B2
C 1165	CHIP CAP.	0.01uF	25V	B	GRM39B103K25PT	K22144803		1-	A	E3
C 1166	CHIP CAP.	0.1uF	16V	B	GRM188B11C104KA01D	K22124805		1-	A	D1
C 1167	CHIP CAP.	0.0047uF	50V	B	GRM188B11H472KA01D	K22174833		1-	B	d2
C 1168	CHIP CAP.	22pF	50V	CH	GRM1882C1H220JA01D	K22174219		1-	B	c2
C 1169	CHIP CAP.	0.1uF	16V	B	GRM188B11C104KA01D	K22124805		1-	A	A2
C 1170	CHIP CAP.	0.1uF	16V	B	GRM188B11C104KA01D	K22124805		1-	A	A2
C 1173	CHIP CAP.	7pF	50V	CH	GRM1882C1H7R0DZ01D	K22174208		1-	B	b2
C 1175	CHIP CAP.	68pF	50V	CH	GRM1882C1H680JA01D	K22174231		1-	B	d2
C 1176	CHIP TA.CAP.	2.2uF	6.3V		TESVA0J225M1-8R	K78080009		1-	A	D1
C 1177	CHIP CAP.	0.1uF	16V	B	GRM188B11C104KA01D	K22124805		1-	A	A2
C 1179	CHIP CAP.	18pF	50V	CH		K22174217	TYP CS1	32-	B	b2



REF.	DESCRIPTION	VALUE	V/W	TOL.	MFR'S DESIG	VXSTD P/N	VERS.	LOT.	SIDE	LAY ADR
C 1180	CHIP CAP.	0.1uF	16V	B	GRM188B11C104KA01D	K22124805		1-	B	c2
C 1184	CHIP CAP.	0.001uF	50V	B	GRM188B11H102KA01D	K22174821		1-	B	c2
C 1187	CHIP CAP.	33pF	50V	CH	GRM1882C1H330JA01D	K22174223		1-44	B	b1
C 1187	CHIP CAP.	39pF	50V	CH	GRM1882C1H390JA01D	K22174225	TYP A	45-	B	b1
C 1187	CHIP CAP.	33pF	50V	CH	GRM1882C1H330JA01D	K22174223	TYP C	45-	B	b1
C 1187	CHIP CAP.	33pF	50V	CH	GRM1882C1H330JA01D	K22174223	TYP CS1	45-	B	b1
C 1188	CHIP CAP.	0.001uF	50V	B	GRM188B11H102KA01D	K22174821		1-	A	E2
C 1191	CHIP CAP.	0.001uF	50V	B	GRM188B11H102KA01D	K22174821		1-	A	E2
C 1193	CHIP CAP.	0.01uF	25V	B	GRM39B103K25PT	K22144803		1-	A	D1
C 1196	CHIP CAP.	0.001uF	50V	B	GRM188B11H102KA01D	K22174821		1-	A	E1
C 1197	CHIP CAP.	0.001uF	50V	B	GRM188B11H102KA01D	K22174821		1-	B	d1
C 1198	CHIP TA.CAP.	4.7uF	6.3V		TEMSVA0J475M-8R	K78080017	VX-180	1-	B	d1
C 1199	CHIP CAP.	0.1uF	16V	B	GRM188B11C104KA01D	K22124805	VX-180	1-	B	d1
C 1200	CHIP CAP.	0.1uF	16V	B	GRM188B11C104KA01D	K22124805	VX-180	1-	A	C1
C 1201	CHIP CAP.	0.1uF	16V	B	GRM188B11C104KA01D	K22124805	VX-180	1-	A	C1
C 1202	CHIP CAP.	680pF	50V	B	GRM188B11H681KA01D	K22174807	VX-180	1-	A	C1
C 1204	CHIP TA.CAP.	4.7uF	6.3V		TEMSVA0J475M-8R	K78080017	VX-180	1-	B	d1
C 1205	CHIP CAP.	22pF	50V	CH	GRM1882C1H220JA01D	K22174219		1-	B	d2
C 1205	CHIP CAP.	27pF	50V	CH	GRM1882C1H270JA01D	K22174221		28-	B	d2
C 1206	CHIP CAP.	0.01uF	25V	B	GRM39B103K25PT	K22144803		1-	B	d1
C 1207	CHIP CAP.	0.01uF	25V	B	GRM39B103K25PT	K22144803		1-	B	e2
C 1208	CHIP CAP.	0.001uF	50V	B	GRM188B11H102KA01D	K22174821		1-	B	c3
C 1209	CHIP CAP.	12pF	50V	CH	GRM1882C1H120JA01D	K22174213		1-	B	c2
C 1209	CHIP CAP.	82pF	50V	CH	GRM1882C1H820JA01D	K22174233		66-	B	c2
C 1210	CHIP CAP.	0.001uF	50V	B	GRM188B11H102KA01D	K22174821		1-	A	D3
C 1211	CHIP CAP.	220pF	50V	CH	GRM1882C1H221JA01D	K22174243		1-	A	D3
C 1212	CHIP CAP.	220pF	50V	CH	GRM1882C1H221JA01D	K22174243		1-	A	D2
C 1213	CHIP CAP.	220pF	50V	CH	GRM1882C1H221JA01D	K22174243		1-	A	D2
C 1222	CHIP CAP.	0.01uF	25V	B	GRM39B103K25PT	K22144803		1-	A	A2
C 1223	CHIP CAP.	0.01uF	25V	B	GRM39B103K25PT	K22144803		1-	A	A2
C 1224	CHIP CAP.	0.0022uF	50V	B	GRM188B11H222KA01D	K22174822		1-	A	A2
C 1226	CHIP CAP.	0.1uF	16V	B	GRM188B11C104KA01D	K22124805		1-	B	e2
C 1227	CHIP CAP.	0.001uF	50V	B	GRM188B11H102KA01D	K22174821		1-	A	E1
C 1228	CHIP TA.CAP.	10uF	6.3V		TEMSVA0J106M-8R	K78080027		1-	A	E2
C 1229	CHIP CAP.	0.1uF	16V	B	GRM188B11C104KA01D	K22124805		1-	B	e2
C 1230	CHIP CAP.	0.1uF	16V	B	GRM188B11C104KA01D	K22124805		1-	B	e2
C 1231	CHIP CAP.	0.1uF	16V	B	GRM188B11C104KA01D	K22124805		1-17	A	A2
C 1232	CHIP TA.CAP.	0.1uF	35V		TESVA1V104M1-8R	K78160025		1-	B	d3
C 1235	CHIP CAP.	330pF	50V	CH	GRM1882C1H331JA01D	K22174253		1-	B	c1
C 1235	CHIP CAP.	330pF	50V	B	GRM188B11H331KD01D	K22174820		3-	B	c1
C 1235	CHIP CAP.	330pF	50V	B	GRM188B11H331KD01D	K22174820		50-53	B	c1
C 1236	CHIP CAP.	0.1uF	16V	B	GRM188B11C104KA01D	K22124805		1-	A	B1
C 1237	CHIP CAP.	180pF	50V	CH	GRM1882C1H181JA01D	K22174241		18-	A	A2
C 1238	CHIP CAP.	0.1uF	16V	B	GRM188B11C104KA01D	K22124805		18-	A	A2
C 1240	CHIP CAP.	0.001uF	50V	B	GRM188B11H102KA01D	K22174821	TYP CS1	61-		
C 1240	CHIP CAP.	0.001uF	50V	B	GRM188B11H102KA01D	K22174821	TYP CS1	100-		
C 1241	CHIP CAP.	2pF	50V	CK	GRM1884C1H2R0CZ01D	K22174203	TYP A	76-79	A	E1
C 1241	CHIP CAP.	0.001uF	50V	B	GRM188B11H102KA01D	K22174821		100-	A	E1
CD1001	CERAMIC DISC				CDBCBA450KCAY24-R0	H7901340		1-	B	d2
CF1001	CERAMIC FILTER				ALFYM450G=K	H3900534		1-	A	C3
CF1002	CERAMIC FILTER				ALFYM450F=K	H3900531		1-	A	C2
D 1002	DIODE				HSU277TRF	G2070118		1-	B	b1
D 1003	DIODE				RLS135 TE-11	G2070128		1-	B	a1
D 1004	DIODE				HVC350B-TRF	G2070596		1-	B	d2
D 1005	DIODE				1SV229 TPH3	G2070256		1-44	B	c2
D 1005	DIODE				HVU358TRF	G2070418	TYP A	45-	B	c2
D 1005	DIODE				1SV229 TPH3	G2070256	TYP A	100-	B	c2
D 1005	DIODE				1SV229 TPH3	G2070256	TYP C	45-	B	c2
D 1005	DIODE				1SV229 TPH3	G2070256	TYP CS1	45-	B	c2
D 1005	DIODE				HVU358TRF	G2070418	TYP CS1	54-	B	c2
D 1006	DIODE				HSU277TRF	G2070118		1-	B	a1
D 1008	DIODE				HSU277TRF	G2070118		1-	B	a2
D 1010	DIODE				1SS355 TE-17	G2070470		1-	B	b1
D 1011	DIODE				HVC358B(TAPE)	G2070590		1-	B	a2

# MAIN Unit

REF.	DESCRIPTION	VALUE	V/W	TOL.	MFR'S DESIG	VXSTD P/N	VERS.	LOT.	SIDE	LAY ADR
D 1012	DIODE				HVC358B(TAPE)	G2070590		1-	B	a2
D 1013	DIODE				HVC358B(TAPE)	G2070590		1-	B	a2
D 1014	DIODE				HVC358B(TAPE)	G2070590		1-	B	a2
D 1015	DIODE				MC2850-T11-1	G2070704		1-	B	f1
D 1016	DIODE				DAN235E TL	G2070612		1-	B	c2
D 1017	DIODE				HVC358B(TAPE)	G2070590		1-60	B	a3
D 1017	DIODE				HVC358B(TAPE)	G2070590	TYP A	61-	B	a3
D 1017	DIODE				HVC358B(TAPE)	G2070590	TYP C	61-	B	a3
D 1018	DIODE				HVC358B(TAPE)	G2070590		1-	B	a3
D 1019	DIODE				HVC358B(TAPE)	G2070590		1-	B	b3
D 1020	DIODE				HVC358B(TAPE)	G2070590		1-	B	b3
D 1021	DIODE				1SS355 TE-17	G2070470		1-	B	e1
D 1022	DIODE				1SS355 TE-17	G2070470		1-	B	e1
D 1023	DIODE				1SS355 TE-17	G2070470		1-	B	e1
D 1024	DIODE				1SS355 TE-17	G2070470		1-	B	e1
D 1025	DIODE				HVC358B(TAPE)	G2070590		1-	B	b3
D 1026	LED				12-22SURYGC/S530-A2/TR8	G2070810		1-	A	F1
D 1028	DIODE				1SS355 TE-17	G2070470		1-	B	e2
D 1028	DIODE				1SS355 TE-17	G2070470		54-	B	e2
D 1030	DIODE				MC2850-T11-1	G2070704		1-	A	A2
D 1031	DIODE				MC2850-T11-1	G2070704		1-	B	c3
D 1032	DIODE				MC2850-T11-1	G2070704		1-	B	c3
D 1034	DIODE				MC2850-T11-1	G2070704		1-	B	c2
D 1035	LED				FA1101F-TR	G2070842	VX-180	1-	A	C3
D 1036	DIODE				1SS355 TE-17	G2070470		1-	B	e2
D 1037	DIODE				HVC358B(TAPE)	G2070590		1-31	B	b2
D 1037	DIODE				HVC358B(TAPE)	G2070590	TYP A	45-	B	b2
D 1037	DIODE				HVC358B(TAPE)	G2070590	TYP C	32-	B	b2
D 1037	DIODE				1SV305(TPH3)	G2070942	TYP CS1	32-	B	b2
D 1038	LED				FA1101F-TR	G2070842	VX-180	1-	A	C1
D 1040	DIODE				1SS355 TE-17	G2070470	VX-180	1-	B	c1
D 1041	DIODE				1SS355 TE-17	G2070470		1-	B	a2
D 1041	DIODE				1SS400 TE61	G2070634		3-	B	a2
D 1042	DIODE				HVU355TRF	G2070410		1-	B	b2
D 1042	DIODE				HVC355B(TAPE)	G2070588		3-31	B	b2
D 1042	DIODE				HVC355B(TAPE)	G2070588	TYP A	45-	B	b2
D 1042	DIODE				HVC355B(TAPE)	G2070588	TYP C	32-	B	b2
D 1042	DIODE				1SV305(TPH3)	G2070942	TYP CS1	32-	B	b2
D 1043	SURGE ABSORBER				TVSF0805	Q9000807		100-	A	F1
D 1043	SURGE ABSORBER				TVSF0603	Q9000847		109-	A	F1
DS1001	LCD				HT-3633-TFZWH	G6090139	VX-180	1-	A	C2
HS1001	HEATSINK PLATE				135t	RA0724500		100-	B	b1
HS1001	HEATSINK PLATE				135t	RA072450A		103-	B	b1
J 1001	SPRING CONECTOR				MS0062-10	S5000227		1-	B	a1
J 1003	CONNECTOR				HSJ1594-010055	P1090896		1-	B	b3
J 1004	SHIELD FINGER				3525 3100103	S5000226		1-	A	D2
J 1005	SHIELD FINGER				3525 3100103	S5000226		1-	A	D2
L 1001	COIL				E2 0.5-2.0-6T-R	L0022488		1-	B	a1
L 1002	COIL				E2 0.5-2.0-6T-R	L0022488		1-	B	a1
L 1003	M.RFC	0.056uH			C2012C-56NK	L1690673		1-	B	b2
L 1003	M.RFC	0.056uH		2%	C2012C-56NG	L1690773		3-38	B	b2
L 1003	M.RFC	0.056uH		2%	C2012C-56NG	L1690773	TYP A	39-	B	b2
L 1003	M.RFC	0.056uH		2%	C2012C-56NG	L1690773	TYP C	39-	B	b2
L 1003	M.RFC	0.068uH		2%	C2012C-68NG	L1690774	TYP CS1	39-	B	b2
L 1003	M.RFC	0.047uH		2%	C2012C-47NG	L1690772	TYP CS1	54-	B	b2
L 1004	COIL				E2 0.35-1.6-7T-L	L0022390		1-38	B	b2
L 1004	COIL				E2 0.3-1.7-7T-R	L0022372	TYP A	39-	B	b2
L 1004	COIL				E2 0.35-1.6-7T-L	L0022390	TYP C	39-	B	b2
L 1004	COIL				E2 0.35-1.6-5.5T-L	L0022616	TYP CS1	39-	B	b2
L 1004	COIL				E2 0.35-1.6-7T-L	L0022390	TYP CS1	54-	B	b2
L 1007	COIL				E2 0.3-1.7-8T-L	L0022376		1-	B	a1
L 1008	COIL				E2 0.3-1.7-8T-L	L0022376		1-	B	a1
L 1009	M.RFC	0.1uH			HK1608 R10J-T	L1690528		1-	B	c1
L 1010	COIL				E2 0.3-1.7-7T-R	L0022372		1-44	B	a2

REF.	DESCRIPTION	VALUE	V/W	TOL.	MFR'S DESIG	VXSTD P/N	VERS.	LOT.	SIDE	LAY ADR
L 1010	COIL				E2 0.3-1.7-8T-L	L0022376	TYP A	45-	B	a2
L 1010	COIL				E2 0.3-1.7-7T-R	L0022372	TYP C	45-	B	a2
L 1010	COIL				E2 0.3-1.7-7T-R	L0022372	TYP CS1	45-	B	a2
L 1011	COIL				E2 0.3-1.7-7T-R	L0022372		1-44	B	a2
L 1011	COIL				E2 0.3-1.7-8T-L	L0022376	TYP A	45-	B	a2
L 1011	COIL				E2 0.3-1.7-7T-R	L0022372	TYP C	45-	B	a2
L 1011	COIL				E2 0.3-1.7-7T-R	L0022372	TYP CS1	45-	B	a2
L 1012	M.RFC	0.1uH			HK1608 R10J-T	L1690528		1-	B	c2
L 1012	M.RFC	0.068uH			HK1608 68NJ-T	L1690526		28-	B	c2
L 1013	M.RFC	0.047uH			HK1608 47NJ-T	L1690524		1-60	B	a2
L 1013	M.RFC	0.047uH			HK1608 47NJ-T	L1690524	TYP A	61-	B	a2
L 1013	M.RFC	0.047uH			HK1608 47NJ-T	L1690524	TYP C	61-	B	a2
L 1014	M.RFC	0.1uH			HK1608 R10J-T	L1690528		1-	B	a2
L 1015	M.RFC	0.056uH			HK1608 56NJ-T	L1690525		1-	B	c1
L 1016	M.RFC	0.047uH			HK1608 47NJ-T	L1690524		1-	B	c1
L 1017	COIL				E2 0.3-1.7-7T-R	L0022372		1-44	B	a3
L 1017	COIL				E2 0.3-1.7-8T-L	L0022376	TYP A	45-	B	a3
L 1017	COIL				E2 0.3-1.7-7T-R	L0022372	TYP C	45-	B	a3
L 1017	COIL				E2 0.3-1.7-7T-R	L0022372	TYP CS1	45-	B	a3
L 1018	COIL				E2 0.35-1.6-7T-L	L0022390		1-	A	D1
L 1020	M.RFC	0.022uH			HK2125 22NK-T	L1690381		1-43	B	b1
L 1020	M.RFC	0.022uH			HK2125 22NK-T	L1690381	TYP A	44-	B	b1
L 1020	M.RFC	0.022uH			HK2125 22NK-T	L1690381	TYP A	50-53	B	b1
L 1020	M.RFC	0.022uH			HK2125 22NK-T	L1690381	TYP C	44-	B	b1
L 1020	M.RFC	0.022uH			HK2125 22NK-T	L1690381	TYP C	50-53	B	b1
L 1020	M.RFC	0.018uH			HK2125 18NK-T	L1690380	TYP CS1	44-	B	b1
L 1020	M.RFC	0.018uH			HK2125 18NK-T	L1690380	TYP CS1	50-53	B	b1
L 1020	M.RFC	0.022uH			HK2125 22NK-T	L1690381		54-	B	b1
L 1021	COIL				E2 0.3-1.7-7T-R	L0022372		1-44	B	b3
L 1021	COIL				E2 0.3-1.7-8T-L	L0022376	TYP A	45-	B	b3
L 1021	COIL				E2 0.3-1.7-7T-R	L0022372	TYP C	45-	B	b3
L 1021	COIL				E2 0.3-1.7-7T-R	L0022372	TYP CS1	45-	B	b3
L 1022	COIL				E2 0.45-1.4-4T-L	L0022391		1-	A	E1
L 1022	COIL				E2 0.45-1.4-4T-L	L0022391		50-	A	E1
L 1022	COIL				E2 0.35-1.6-7T-L	L0022390		54-	A	E1
L 1023	M.RFC	0.082uH			HK1608 82NJ-T	L1690527		1-44	B	b2
L 1023	M.RFC	0.1uH			HK1608 R10J-T	L1690528	TYP A	45-	B	b2
L 1023	M.RFC	0.082uH			HK1608 82NJ-T	L1690527	TYP C	45-	B	b2
L 1023	M.RFC	0.082uH			HK1608 82NJ-T	L1690527	TYP CS1	45-	B	b2
L 1024	COIL				E2 0.5-1.4-2.5T-L	L0022613		1-	B	b1
L 1025	COIL				E2 0.5-2.0-5T-R	L0022487		1-	B	b1
L 1026	M.RFC	0.82uH			LK1608 R82K-T	L1690417		1-	B	b2
L 1027	M.RFC	0.82uH			LK2125 R82K-T	L1690318		1-	B	a1
L 1029	M.RFC	0.82uH			LK1608 R82K-T	L1690417		1-	B	c2
L 1029	M.RFC	0.15uH			HK1608 R15J-T	L1690938		66-	B	c2
L 1030	M.RFC	3.3uH			LK1608 3R3K-T	L1690686		1-	B	b2
L 1032	M.RFC	0.022uH			HK1608 22NJ-T	L1690520		1-43	B	b1
L 1032	M.RFC	0.022uH			HK1608 22NJ-T	L1690520	TYP A	44-	B	b1
L 1032	M.RFC	0.022uH			HK1608 22NJ-T	L1690520	TYP A	50-53	B	b1
L 1032	M.RFC	0.022uH			HK1608 22NJ-T	L1690520	TYP C	44-	B	b1
L 1032	M.RFC	0.022uH			HK1608 22NJ-T	L1690520	TYP C	50-53	B	b1
L 1032	M.RFC	0.047uH			HK1608 47NJ-T	L1690524	TYP CS1	44-	B	b1
L 1032	M.RFC	0.047uH			HK1608 47NJ-T	L1690524	TYP CS1	50-53	B	b1
L 1032	M.RFC	0.22uH			HK1608 R22J-T	L1690940		54-	B	b1
L 1033	M.RFC	0.082uH			HK1608 82NJ-T	L1690527		1-	B	c1
L 1034	M.RFC	0.068uH			LK1608 68NM-T	L1690406		1-	B	c1
L 1034	M.RFC	0.068uH			LK1608 68NM-T	L1690406		50-53	B	c1
MC1001	MIC. ELEMENT				EM-100PT	M3290029		1-	A	D1
Q 1002	TRANSISTOR				2SC5231C8-TL	G3352318H		1-	B	c2
Q 1005	IC				MB15A02PFV1-G-BND-EF	G1092541		1-	B	d1
Q 1007	TRANSISTOR				2SC5005-T1	G3350058		1-	B	c2
Q 1008	TRANSISTOR				2SC4154-T11-1E	G3341548E		1-	B	b2
Q 1010	IC				BR93LC66FV-E2	G1092853		1-	B	e2
Q 1010	IC				BR93L66FV-WE2	G1093910		38-	B	e2

# MAIN Unit

REF.	DESCRIPTION	VALUE	V/W	TOL.	MFR'S DESIG	VXSTD P/N	VERS.	LOT.	SIDE	LAY ADR
Q 1011	TRANSISTOR				2SA1586Y TE85R	G3115867Y		1-	A	A1
Q 1012	TRANSISTOR				2SC5006-T1	G3350068		1-	B	a2
Q 1013	TRANSISTOR				RT1P441U-T11-1	G3070248		1-	B	f1
Q 1014	IC				M37516E6HP(NO PROG.)	✕		1-	B	e1
Q 1014	IC				M37516M6-121HP	✕		5-	B	e1
Q 1014	IC				M37516M6-146HP	✕		28-	B	e1
Q 1014	IC				M37516M6-182HP	✕		70-	B	e1
Q 1015	TRANSISTOR				2SC5227-4-TB	G3352278D		1-	B	c1
Q 1016	FET				2SK2596BXTL	G3825967		1-	B	c1
Q 1017	IC				NJM2902V-TE1	G1091679		1-	A	A1
Q 1020	TRANSISTOR				RT1P441U-T11-1	G3070248		1-	B	e1
Q 1024	FET				2SK2974-T11	G3829747		1-	A	D1
Q 1024	FET				2SK2974-T11	G3829747		50-	A	D1
Q 1024	FET				RD07MVS1-T12	G3070320		54-	A	D1
Q 1024	FET				RD07MVS1-T12(A)	G3070320A		102	A	D1
Q 1024	FET				RD07MVS1A-T12	G3070352		103-	A	D1
Q 1025	TRANSISTOR				2SC4154-T11-1E	G3341548E		1-	A	F1
Q 1026	FET				SGM2016AM-T7	G4070012		1-	B	b2
Q 1026	FET				3SK299-T1(U73)	G4802998		109-	B	b2
Q 1027	TRANSISTOR				FMW1 T98	G3070009		1-	B	e3
Q 1028	TRANSISTOR				FMW1 T98	G3070009		1-	B	f3
Q 1029	TRANSISTOR				CPH6102-TL	G3070223		1-	B	e3
Q 1030	IC				NJM2902V-TE1	G1091679		1-	A	A2
Q 1031	TRANSISTOR				CPH6102-TL	G3070223		1-	B	f2
Q 1032	TRANSISTOR				FMW1 T98	G3070009		1-	A	E2
Q 1033	TRANSISTOR				2SC4215Y TE85R	G3342157Y		1-	B	c2
Q 1034	TRANSISTOR				RT1N441U-T11-1	G3070247		1-	B	e2
Q 1036	TRANSISTOR				DTB123EK T146	G3070022		1-	B	e3
Q 1037	IC				TA31136FN(EL)	G1091605		1-	B	d2
Q 1038	TRANSISTOR				2SC4154-T11-1E	G3341548E		1-	A	E2
Q 1039	IC				NJM2070M-TE2	G1092944		1-	A	E2
Q 1040	IC				TK11250BMCL	G1092952		1-	B	f2
Q 1040	IC				TK11250CMCL-G	G1093694		34-	B	f2
Q 1041	IC				S-80735SN-DZ-T1	G1091876		1-	B	e2
Q 1041	IC				S-80835CNMC-B8U-T2-G	G1093606		28-	B	e2
Q 1042	TRANSISTOR				RT1N441U-T11-1	G3070247		1-	A	A2
Q 1043	TRANSISTOR				2SA1586Y TE85R	G3115867Y		1-	A	A2
Q 1045	TRANSISTOR				RT1N441U-T11-1	G3070247		1-	B	d2
Q 1049	IC				NJM12903R-TE1	G1093336		1-	A	A2
Q 1050	TRANSISTOR				2SC4154-T11-1E	G3341548E		1-	A	A3
Q 1051	TRANSISTOR				CPH6102-TL	G3070223		1-	A	E2
Q 1052	IC				M62364FP 600D	G1093033		1-	B	e3
Q 1053	TRANSISTOR				RT1N441U-T11-1	G3070247		1-	A	C1
Q 1054	IC				LC75834W	G1093288	VX-180	1-	A	C2
Q 1055	TRANSISTOR				2SC4154-T11-1E	G3341548E		1-	B	e2
Q 1056	TRANSISTOR				2SA1586Y TE85R	G3115867Y		1-	B	d1
Q 1057	TRANSISTOR				IMZ2A T108	G3070060		1-	A	E1
Q 1058	TRANSISTOR				DTC124TE TL	G3070128	VX-180	1-	A	C1
Q 1059	TRANSISTOR				RT1P441U-T11-1	G3070248		1-	B	b2
Q 1060	TRANSISTOR				RT1P441U-T11-1	G3070248		1-	A	E2
Q 1061	TRANSISTOR				2SC4154-T11-1E	G3341548E	VX-180	1-	A	C1
Q 1062	TRANSISTOR				2SA1586Y TE85R	G3115867Y		1-	B	c1
Q 1063	TRANSISTOR				RT1N441U-T11-1	G3070247		1-	B	c1
R 1001	CHIP RES.	0	1/16W	5%	RMC1/16 000JATP	J24185000		1-	B	b2
R 1002	CHIP RES.	10k	1/16W	5%	RMC1/16 103JATP	J24185103		1-44	B	d2
R 1002	CHIP RES.	4.7k	1/16W	5%	RMC1/16 472JATP	J24185472	TYP A	45-	B	d2
R 1002	CHIP RES.	10k	1/16W	5%	RMC1/16 103JATP	J24185103	TYP C	45-	B	d2
R 1002	CHIP RES.	10k	1/16W	5%	RMC1/16 103JATP	J24185103	TYP CS1	45-	B	d2
R 1002	CHIP RES.	100k	1/16W	5%	RMC1/16 104JATP	J24185104	TYP CS1	100	B	d2
R 1002	CHIP RES.	10k	1/16W	5%	RMC1/16 103JATP	J24185103	TYP CS1	101-	B	d2
R 1003	CHIP RES.	56k	1/16W	5%	RMC1/16 563JATP	J24185563		1-44	B	d2
R 1003	CHIP RES.	33k	1/16W	5%	RMC1/16 333JATP	J24185333	TYP A	45-	B	d2
R 1003	CHIP RES.	56k	1/16W	5%	RMC1/16 563JATP	J24185563	TYP C	45-	B	d2
R 1003	CHIP RES.	56k	1/16W	5%	RMC1/16 563JATP	J24185563	TYP CS1	45-	B	d2

✕: Please contact VERTEX STANDARD

# MAIN Unit

REF.	DESCRIPTION	VALUE	V/W	TOL.	MFR'S DESIG	VXSTD P/N	VERS.	LOT.	SIDE	LAY ADR
R 1003	CHIP RES.	560k	1/16W	5%	RMC1/16 564JATP	J24185564	TYP CS1	100	B	d2
R 1003	CHIP RES.	56k	1/16W	5%	RMC1/16 563JATP	J24185563	TYP CS1	101-	B	d2
R 1004	CHIP RES.	3.3k	1/16W	5%	RMC1/16 332JATP	J24185332		1-	B	c2
R 1005	CHIP RES.	10k	1/16W	5%	RMC1/16 103JATP	J24185103		1-53	B	c1
R 1005	CHIP RES.	10k	1/16W	5%	RMC1/16 103JATP	J24185103	TYP A	54-	B	c1
R 1005	CHIP RES.	10k	1/16W	5%	RMC1/16 103JATP	J24185103	TYP C	54-	B	c1
R 1005	CHIP RES.	3.3k	1/16W	5%	RMC1/16 332JATP	J24185332	TYP CS1	54-	B	c1
R 1006	CHIP RES.	47k	1/16W	5%	RMC1/16 473JATP	J24185473		1-	B	b1
R 1007	CHIP RES.	3.3k	1/16W	5%	RMC1/16 332JATP	J24185332		1-	B	d2
R 1008	CHIP RES.	82k	1/16W	5%	RMC1/16 823JATP	J24185823		1-	A	A1
R 1009	CHIP RES.	100k	1/16W	5%	RMC1/16 104JATP	J24185104		1-	B	d3
R 1011	CHIP RES.	1.2k	1/16W	5%	RMC1/16 122JATP	J24185122		1-31	B	d2
R 1011	CHIP RES.	1.2k	1/16W	5%	RMC1/16 122JATP	J24185122	TYP A	45-	B	d2
R 1011	CHIP RES.	1k	1/16W	5%	RMC1/16 102JATP	J24185102	TYP A	100-	B	d2
R 1011	CHIP RES.	1.2k	1/16W	5%	RMC1/16 122JATP	J24185122	TYP C	32-	B	d2
R 1011	CHIP RES.	1k	1/16W	5%	RMC1/16 102JATP	J24185102	TYP C	100-	B	d2
R 1011	CHIP RES.	1k	1/16W	5%	RMC1/16 102JATP	J24185102	TYP CS1	32-	B	d2
R 1011	CHIP RES.	680	1/16W	5%	RMC1/16 681JATP	J24185681	TYP CS1	100-	B	d2
R 1012	CHIP RES.	68k	1/16W	5%	RMC1/16 683JATP	J24185683		1-	A	A1
R 1013	CHIP RES.	100k	1/16W	5%	RMC1/16 104JATP	J24185104		1-	B	d3
R 1014	CHIP RES.	820	1/16W	5%	RMC1/16 821JATP	J24185821		1-	B	c2
R 1015	CHIP RES.	0	1/16W	5%	RMC1/16 000JATP	J24185000		1-	B	c2
R 1016	CHIP RES.	33k	1/16W	5%	RMC1/16 333JATP	J24185333		1-	B	c2
R 1017	CHIP RES.	2.2k	1/16W	5%	RMC1/16 222JATP	J24185222		1-	B	d2
R 1018	CHIP RES.	0	1/16W	5%	RMC1/16 000JATP	J24185000		54-	B	c1
R 1019	CHIP RES.	100k	1/16W	5%	RMC1/16 104JATP	J24185104		1-	B	c2
R 1020	CHIP RES.	47k	1/16W	5%	RMC1/16 473JATP	J24185473		1-	A	A1
R 1021	CHIP RES.	100k	1/16W	5%	RMC1/16 104JATP	J24185104		1-	B	d2
R 1023	CHIP RES.	0	1/16W	5%	RMC1/16 000JATP	J24185000		1-	B	d2
R 1024	CHIP RES.	0	1/16W	5%	RMC1/16 000JATP	J24185000		1-	B	d2
R 1025	CHIP RES.	100k	1/16W	5%	RMC1/16 104JATP	J24185104		1-	A	A1
R 1026	CHIP RES.	68k	1/16W	5%	RMC1/16 683JATP	J24185683		1-	B	e2
R 1027	CHIP RES.	100k	1/16W	5%	RMC1/16 104JATP	J24185104		1-	A	A1
R 1028	CHIP RES.	0	1/16W	5%	RMC1/16 000JATP	J24185000		1-17	A	A2
R 1029	CHIP RES.	47k	1/16W	5%	RMC1/16 473JATP	J24185473		1-	B	c1
R 1030	CHIP RES.	220	1/16W	5%	RMC1/16 221JATP	J24185221		1-	B	c1
R 1031	CHIP RES.	0	1/16W	5%	RMC1/16 000JATP	J24185000		1-	B	e2
R 1032	CHIP RES.	27k	1/16W	5%	RMC1/16 273JATP	J24185273		1-	A	A1
R 1033	CHIP RES.	4.7k	1/16W	5%	RMC1/16 472JATP	J24185472		1-	B	b2
R 1034	CHIP RES.	1k	1/16W	5%	RMC1/16 102JATP	J24185102		1-	A	C1
R 1035	CHIP RES.	39k	1/16W	5%	RMC1/16 393JATP	J24185393		1-	A	A1
R 1036	CHIP RES.	2.2k	1/16W	5%	RMC1/16 222JATP	J24185222		1-	B	d1
R 1037	CHIP RES.	2.2k	1/16W	5%	RMC1/16 222JATP	J24185222		1-	B	d1
R 1038	CHIP RES.	2.2k	1/16W	5%	RMC1/16 222JATP	J24185222		1-	B	d1
R 1039	CHIP RES.	10k	1/16W	5%	RMC1/16 103JATP	J24185103		1-	B	e2
R 1040	CHIP RES.	39k	1/16W	5%	RMC1/16 393JATP	J24185393		1-	A	A1
R 1041	CHIP RES.	100k	1/16W	5%	RMC1/16 104JATP	J24185104		1-	B	a2
R 1042	CHIP RES.	68k	1/16W	5%	RMC1/16 683JATP	J24185683		1-	B	e2
R 1043	CHIP RES.	1.2M	1/16W	5%	RMC1/16 125JATP	J24185125		1-	A	A1
R 1044	CHIP RES.	0	1/16W	5%	RMC1/16 000JATP	J24185000		3-	B	e3
R 1045	CHIP RES.	0	1/16W	5%	RMC1/16 000JATP	J24185000		1-	B	c2
R 1047	CHIP RES.	100k	1/16W	5%	RMC1/16 104JATP	J24185104		1-	B	a2
R 1048	CHIP RES.	1.8M	1/16W	5%	RMC1/16 185JATP	J24185185		1-	A	A2
R 1049	CHIP RES.	1.8k	1/16W	5%	RMC1/16 182JATP	J24185182		1-	A	A1
R 1050	CHIP RES.	47k	1/16W	5%	RMC1/16 473JATP	J24185473		1-	A	A1
R 1051	CHIP RES.	10k	1/16W	1%	RMC1/16 103FTP	J24183103		1-	A	A1
R 1052	CHIP RES.	220k	1/16W	1%	RMC1/16 224FTP	J24183224		1-	A	A1
R 1053	CHIP RES.	10k	1/16W	5%	RMC1/16 103JATP	J24185103		1-	B	e2
R 1054	CHIP RES.	5.6k	1/16W	5%	RMC1/16 562JATP	J24185562		1-	A	A2
R 1055	CHIP RES.	47k	1/16W	5%	RMC1/16 473JATP	J24185473		1-	A	A1
R 1056	CHIP RES.	10k	1/16W	5%	RMC1/16 103JATP	J24185103		1-	B	e1
R 1057	CHIP RES.	82k	1/16W	5%	RMC1/16 823JATP	J24185823		1-	B	e1
R 1058	CHIP RES.	39k	1/16W	5%	RMC1/16 393JATP	J24185393		1-	B	e1
R 1059	CHIP RES.	22k	1/16W	5%	RMC1/16 223JATP	J24185223		1-	B	e1



# MAIN Unit

REF.	DESCRIPTION	VALUE	V/W	TOL.	MFR'S DESIG	VXSTD P/N	VERS.	LOT.	SIDE	LAY ADR
R 1060	CHIP RES.	2.2k	1/16W	5%	RMC1/16 222JATP	J24185222		28-	B	d2
R 1061	CHIP RES.	10k	1/16W	5%	RMC1/16 103JATP	J24185103		1-	B	f2
R 1062	CHIP RES.	100k	1/16W	5%	RMC1/16 104JATP	J24185104		1-	B	a2
R 1063	CHIP RES.	3.9k	1/16W	5%	RMC1/16 392JATP	J24185392		1-	B	c2
R 1064	CHIP RES.	330k	1/16W	1%	RMC1/16 334FTP	J24183334		1-	B	e2
R 1065	CHIP RES.	82k	1/16W	1%	RMC1/16 823FTP	J24183823		1-	B	e1
R 1066	CHIP RES.	27k	1/16W	5%	RMC1/16 273JATP	J24185273		1-	A	A1
R 1067	CHIP RES.	2.2k	1/16W	5%	RMC1/16 222JATP	J24185222		1-	A	A1
R 1068	CHIP RES.	1k	1/16W	5%	RMC1/16 102JATP	J24185102		1-31	B	a2
R 1068	CHIP RES.	1k	1/16W	5%	RMC1/16 102JATP	J24185102	TYP A	45-	B	a2
R 1068	CHIP RES.	1k	1/16W	5%	RMC1/16 102JATP	J24185102	TYP C	32-	B	a2
R 1068	CHIP RES.	100	1/16W	5%	RMC1/16 101JATP	J24185101	TYP CS1	32-	B	a2
R 1069	CHIP RES.	0	1/16W	5%	RMC1/16 000JATP	J24185000		3-43	B	d1
R 1069	CHIP RES.	0	1/16W	5%	RMC1/16 000JATP	J24185000	TYP A	44-	B	d1
R 1069	CHIP RES.	0	1/16W	5%	RMC1/16 000JATP	J24185000	TYP A	50-53	B	d1
R 1069	CHIP RES.	0	1/16W	5%	RMC1/16 000JATP	J24185000	TYP C	44-	B	d1
R 1069	CHIP RES.	0	1/16W	5%	RMC1/16 000JATP	J24185000	TYP C	50-53	B	d1
R 1069	CHIP RES.	2.2k	1/16W	5%	RMC1/16 222JATP	J24185222	TYP CS1	44-	B	d1
R 1069	CHIP RES.	2.2k	1/16W	5%	RMC1/16 222JATP	J24185222	TYP CS1	50-53	B	d1
R 1069	CHIP RES.	2.2k	1/16W	5%	RMC1/16 222JATP	J24185222		54-	B	d1
R 1070	CHIP RES.	470	1/16W	5%	RMC1/16 471JATP	J24185471		1-	B	f1
R 1071	CHIP RES.	1.5M	1/16W	5%	RMC1/16 155JATP	J24185155		1-	A	B1
R 1072	CHIP RES.	47k	1/16W	5%	RMC1/16 473JATP	J24185473		1-	B	c1
R 1073	CHIP RES.	100	1/16W	5%	RMC1/16 101JATP	J24185101		1-	B	f1
R 1074	CHIP RES.	100	1/16W	5%	RMC1/16 101JATP	J24185101		1-	B	a2
R 1075	CHIP RES.	2.2k	1/16W	5%	RMC1/16 222JATP	J24185222		1-	B	a2
R 1076	CHIP RES.	220k	1/16W	5%	RMC1/16 224JATP	J24185224		18-	B	e2
R 1077	CHIP RES.	15k	1/16W	5%	RMC1/16 153JATP	J24185153		1-	B	d1
R 1077	CHIP RES.	10k	1/16W	5%	RMC1/16 103JATP	J24185103		28-	B	d1
R 1078	CHIP RES.	15	1/16W	5%	RMC1/16 150JATP	J24185150		1-	B	d1
R 1078	CHIP RES.	47	1/16W	5%	RMC1/16 470JATP	J24185470		28-43	B	d1
R 1078	CHIP RES.	47	1/16W	5%	RMC1/16 470JATP	J24185470	TYP A	44-	B	d1
R 1078	CHIP RES.	47	1/16W	5%	RMC1/16 470JATP	J24185470	TYP A	50-53	B	d1
R 1078	CHIP RES.	47	1/16W	5%	RMC1/16 470JATP	J24185470	TYP C	44-	B	d1
R 1078	CHIP RES.	47	1/16W	5%	RMC1/16 470JATP	J24185470	TYP C	50-53	B	d1
R 1078	CHIP RES.	15	1/16W	5%	RMC1/16 150JATP	J24185150	TYP CS1	44-	B	d1
R 1078	CHIP RES.	15	1/16W	5%	RMC1/16 150JATP	J24185150	TYP CS1	50-53	B	d1
R 1078	CHIP RES.	47	1/16W	5%	RMC1/16 470JATP	J24185470		54-99	B	d1
R 1078	CHIP RES.	47	1/16W	5%	RMC1/16 470JATP	J24185470	TYP A	100-	B	d1
R 1078	CHIP RES.	68	1/16W	5%	RMC1/16 680JATP	J24185680	TYP C	100-	B	d1
R 1078	CHIP RES.	68	1/16W	5%	RMC1/16 680JATP	J24185680	TYP CS1	100-	B	d1
R 1079	CHIP RES.	10k	1/16W	5%	RMC1/16 103JATP	J24185103		1-	A	B1
R 1080	CHIP RES.	100k	1/16W	5%	RMC1/16 104JATP	J24185104		1-65	B	a2
R 1080	CHIP RES.	100k	1/16W	5%	RMC1/16 104JATP	J24185104	TYP A	66-	B	a2
R 1080	CHIP RES.	100k	1/16W	5%	RMC1/16 104JATP	J24185104	TYP C	66-	B	a2
R 1081	CHIP RES.	100k	1/16W	5%	RMC1/16 104JATP	J24185104		1-	A	A2
R 1082	CHIP RES.	100k	1/16W	5%	RMC1/16 104JATP	J24185104		1-	A	A2
R 1083	CHIP RES.	10k	1/16W	5%	RMC1/16 103JATP	J24185103		1-	A	B1
R 1084	CHIP RES.	100k	1/16W	5%	RMC1/16 104JATP	J24185104		1-65	B	a3
R 1084	CHIP RES.	100k	1/16W	5%	RMC1/16 104JATP	J24185104	TYP A	66-	B	a3
R 1084	CHIP RES.	100k	1/16W	5%	RMC1/16 104JATP	J24185104	TYP C	66-	B	a3
R 1085	CHIP RES.	100k	1/16W	5%	RMC1/16 104JATP	J24185104		1-	A	A2
R 1086	CHIP RES.	100k	1/16W	5%	RMC1/16 104JATP	J24185104		1-	A	A2
R 1087	CHIP RES.	12k	1/16W	5%	RMC1/16 123JATP	J24185123		1-	B	c1
R 1087	CHIP RES.	12k	1/16W	5%	RMC1/16 123JATP	J24185123		50-	B	c1
R 1087	CHIP RES.	10k	1/16W	5%	RMC1/16 103JATP	J24185103		54-	B	c1
R 1089	CHIP RES.	100	1/16W	5%	RMC1/16 101JATP	J24185101		1-44	B	c1
R 1089	CHIP RES.	56	1/16W	5%	RMC1/16 560JATP	J24185560	TYP A	45-53	B	c1
R 1089	CHIP RES.	100	1/16W	5%	RMC1/16 101JATP	J24185101	TYP C	45-53	B	c1
R 1089	CHIP RES.	100	1/16W	5%	RMC1/16 101JATP	J24185101	TYP CS1	45-53	B	c1
R 1089	CHIP RES.	100	1/16W	5%	RMC1/16 101JATP	J24185101		54-75	B	c1
R 1089	CHIP RES.	47	1/16W	5%	RMC1/16 470JATP	J24185470	TYP A	76-	B	c1
R 1089	CHIP RES.	100	1/16W	5%	RMC1/16 101JATP	J24185101	TYP C	76-	B	c1
R 1089	CHIP RES.	100	1/16W	5%	RMC1/16 101JATP	J24185101	TYP CS1	76-	B	c1

REF.	DESCRIPTION	VALUE	V/W	TOL.	MFR'S DESIG	VXSTD P/N	VERS.	LOT.	SIDE	LAY ADR
R 1090	CHIP RES.	5.6k	1/16W	5%	RMC1/16 562JATP	J24185562		1-	B	c1
R 1090	CHIP RES.	8.2k	1/16W	5%	RMC1/16 822JATP	J24185822		103-	B	c1
R 1091	CHIP RES.	100k	1/16W	5%	RMC1/16 104JATP	J24185104		1-	B	a2
R 1093	CHIP RES.	22	1/2W	5%	RMC1/2 220JCTP	J24275220		1-	A	D1
R 1094	CHIP RES.	2.2k	1/16W	5%	RMC1/16 222JATP	J24185222		1-	B	f2
R 1095	CHIP RES.	2.2k	1/16W	5%	RMC1/16 222JATP	J24185222		1-	B	f2
R 1098	CHIP RES.	100k	1/16W	5%	RMC1/16 104JATP	J24185104		1-	B	b3
R 1099	CHIP RES.	1k	1/16W	5%	RMC1/16 102JATP	J24185102		1-	B	c1
R 1100	CHIP RES.	330	1/16W	5%	RMC1/16 331JATP	J24185331		1-	A	F1
R 1103	CHIP RES.	1k	1/16W	5%	RMC1/16 102JATP	J24185102		1-	B	b2
R 1104	CHIP RES.	470	1/16W	5%	RMC1/16 471JATP	J24185471		1-	A	F1
R 1105	CHIP RES.	1k	1/16W	5%	RMC1/16 102JATP	J24185102		1-	A	F2
R 1106	CHIP RES.	1k	1/16W	5%	RMC1/16 102JATP	J24185102		1-27	B	b2
R 1107	CHIP RES.	220	1W	5%	RMC1 221JTE	J24305221		1-	A	E1
R 1108	CHIP RES.	0.33	1/8W	10%	RMC1/8 R33KTP	J24219001		1-	A	E1
R 1109	CHIP RES.	22	1/16W	5%	RMC1/16 220JATP	J24185220		1-	B	a2
R 1109	CHIP RES.	82	1/16W	5%	RMC1/16 820JATP	J24185820		28-	B	a2
R 1109	CHIP RES.	180	1/16W	5%	RMC1/16 181JATP	J24185181		109-	B	a2
R 1110	CHIP RES.	470	1/16W	5%	RMC1/16 471JATP	J24185471		1-	B	b2
R 1111	CHIP RES.	10k	1/16W	5%	RMC1/16 103JATP	J24185103		1-	B	e3
R 1112	CHIP RES.	10k	1/16W	5%	RMC1/16 103JATP	J24185103		1-	B	e3
R 1113	CHIP RES.	27k	1/16W	5%	RMC1/16 273JATP	J24185273		1-	A	E1
R 1113	CHIP RES.	27k	1/16W	5%	RMC1/16 273JATP	J24185273		50-	A	E1
R 1113	CHIP RES.	5.6k	1/16W	5%	RMC1/16 562JATP	J24185562		54-	A	E1
R 1114	CHIP RES.	27k	1/16W	5%	RMC1/16 273JATP	J24185273		1-	A	E1
R 1114	CHIP RES.	27k	1/16W	5%	RMC1/16 273JATP	J24185273		50-	A	E1
R 1114	CHIP RES.	6.8k	1/16W	5%	RMC1/16 682JATP	J24185682		54-	A	E1
R 1115	CHIP RES.	0.33	1/8W	10%	RMC1/8 R33KTP	J24219001		1-	A	E1
R 1116	CHIP RES.	3.3k	1/16W	5%	RMC1/16 332JATP	J24185332		1-	B	e3
R 1117	CHIP RES.	3.3k	1/16W	5%	RMC1/16 332JATP	J24185332		1-	B	e3
R 1118	CHIP RES.	0	1/16W	5%	RMC1/16 000JATP	J24185000		1-	A	E1
R 1119	CHIP RES.	3.3k	1/16W	5%	RMC1/16 332JATP	J24185332		1-	B	e3
R 1121	CHIP RES.	3.3k	1/16W	5%	RMC1/16 332JATP	J24185332		1-	B	f2
R 1123	CHIP RES.	330	1/16W	5%	RMC1/16 331JATP	J24185331		1-	A	E2
R 1124	CHIP RES.	0	1/16W	5%	RMC1/16 000JATP	J24185000		1-31	B	c2
R 1124	CHIP RES.	0	1/16W	5%	RMC1/16 000JATP	J24185000	TYP A	45-	B	c2
R 1124	CHIP RES.	0	1/16W	5%	RMC1/16 000JATP	J24185000	TYP C	32-	B	c2
R 1124	CHIP RES.	390	1/16W	5%	RMC1/16 391JATP	J24185391	TYP CS1	32-	B	c2
R 1125	CHIP RES.	0.33	1/8W	10%	RMC1/8 R33KTP	J24219001		1-	A	E1
R 1126	CHIP RES.	22	1/16W	5%	RMC1/16 220JATP	J24185220		1-	B	b3
R 1127	CHIP RES.	68	1/16W	5%	RMC1/16 680JATP	J24185680		1-	B	b1
R 1128	CHIP RES.	47k	1/16W	5%	RMC1/16 473JATP	J24185473		1-	B	c2
R 1129	CHIP RES.	330	1/16W	5%	RMC1/16 331JATP	J24185331		1-	A	F1
R 1130	CHIP RES.	10k	1/16W	5%	RMC1/16 103JATP	J24185103		1-	A	E1
R 1132	CHIP RES.	1k	1/16W	5%	RMC1/16 102JATP	J24185102		1-	B	c2
R 1133	CHIP RES.	470	1/16W	5%	RMC1/16 471JATP	J24185471		1-	A	C1
R 1134	CHIP RES.	47k	1/16W	5%	RMC1/16 473JATP	J24185473		1-	B	e2
R 1135	CHIP RES.	47k	1/16W	5%	RMC1/16 473JATP	J24185473		1-	A	A1
R 1136	CHIP RES.	10k	1/16W	5%	RMC1/16 103JATP	J24185103		1-	A	A1
R 1137	CHIP RES.	470k	1/16W	5%	RMC1/16 474JATP	J24185474		1-	B	e2
R 1137	CHIP RES.	470k	1/16W	5%	RMC1/16 474JATP	J24185474		54-	B	e2
R 1138	CHIP RES.	100k	1/16W	5%	RMC1/16 104JATP	J24185104		1-	A	A3
R 1139	CHIP RES.	47k	1/16W	5%	RMC1/16 473JATP	J24185473		1-	A	E2
R 1140	CHIP RES.	100	1/16W	5%	RMC1/16 101JATP	J24185101		1-	A	F2
R 1141	CHIP RES.	470	1/10W	5%	RMC1/10T 471J	J24205471		1-	A	E2
R 1142	CHIP RES.	3.3k	1/16W	5%	RMC1/16 332JATP	J24185332		1-	B	d2
R 1142	CHIP RES.	3.3k	1/16W	5%	RMC1/16 332JATP	J24185332		54-	B	d2
R 1143	CHIP RES.	47k	1/16W	5%	RMC1/16 473JATP	J24185473		1-	B	e2
R 1145	CHIP RES.	2.2k	1/16W	5%	RMC1/16 222JATP	J24185222		1-	A	A3
R 1146	CHIP RES.	12k	1/16W	5%	RMC1/16 123JATP	J24185123		1-	B	c3
R 1147	CHIP RES.	100k	1/16W	5%	RMC1/16 104JATP	J24185104		1-	A	A2
R 1147	CHIP RES.	56k	1/16W	5%	RMC1/16 563JATP	J24185563		18-	A	A2
R 1148	CHIP RES.	47k	1/16W	5%	RMC1/16 473JATP	J24185473		1-	A	A2
R 1149	CHIP RES.	18k	1/16W	5%	RMC1/16 183JATP	J24185183		1-101	A	A2

# MAIN Unit

REF.	DESCRIPTION	VALUE	V/W	TOL.	MFR'S DESIG	VXSTD P/N	VERS.	LOT.	SIDE	LAY ADR
R 1149	CHIP RES.	18k	1/16W	5%	RMC1/16 183JATP	J24185183	EXP	102-	A	A2
R 1149	CHIP RES.	18k	1/16W	5%	RMC1/16 183JATP	J24185183	VTX	102-	A	A2
R 1150	CHIP RES.	150k	1/16W	5%	RMC1/16 154JATP	J24185154		1-	B	d2
R 1150	CHIP RES.	150k	1/16W	5%	RMC1/16 154JATP	J24185154		54-	B	d2
R 1151	CHIP RES.	2.7k	1/16W	5%	RMC1/16 272JATP	J24185272		1-	B	d2
R 1152	CHIP RES.	12k	1/16W	5%	RMC1/16 123JATP	J24185123		1-	B	c2
R 1153	CHIP RES.	2.2k	1/16W	5%	RMC1/16 222JATP	J24185222		1-	B	d2
R 1153	CHIP RES.	2.2k	1/16W	5%	RMC1/16 222JATP	J24185222		54-	B	d2
R 1154	CHIP RES.	2.2k	1/16W	5%	RMC1/16 222JATP	J24185222		1-	B	d2
R 1155	CHIP RES.	4.7k	1/16W	5%	RMC1/16 472JATP	J24185472		1-	B	d2
R 1156	CHIP RES.	1.8k	1/16W	5%	RMC1/16 182JATP	J24185182		1-	B	d3
R 1156	CHIP RES.	1.8k	1/16W	5%	RMC1/16 182JATP	J24185182		54-	B	d3
R 1157	CHIP RES.	12k	1/16W	5%	RMC1/16 123JATP	J24185123		1-	B	c2
R 1158	CHIP RES.	12k	1/16W	5%	RMC1/16 123JATP	J24185123		1-	B	c2
R 1159	CHIP RES.	120k	1/16W	5%	RMC1/16 124JATP	J24185124		1-	A	A2
R 1159	CHIP RES.	82k	1/16W	5%	RMC1/16 823JATP	J24185823		18-	A	A2
R 1160	CHIP RES.	47k	1/16W	5%	RMC1/16 473JATP	J24185473		1-	A	A3
R 1161	CHIP RES.	100k	1/16W	5%	RMC1/16 104JATP	J24185104		1-	B	e2
R 1161	CHIP RES.	15k	1/16W	5%	RMC1/16 153JATP	J24185153		18-	B	e2
R 1162	CHIP RES.	1k	1/16W	5%	RMC1/16 102JATP	J24185102		1-	A	F2
R 1164	CHIP RES.	47k	1/16W	5%	RMC1/16 473JATP	J24185473		1-	B	e2
R 1164	CHIP RES.	6.8k	1/16W	5%	RMC1/16 682JATP	J24185682		18-	B	e2
R 1165	CHIP RES.	150k	1/16W	5%	RMC1/16 154JATP	J24185154		1-	A	A2
R 1165	CHIP RES.	180k	1/16W	5%	RMC1/16 184JATP	J24185184		18-	A	A2
R 1166	CHIP RES.	2.2	1/16W	5%	RMC1/16 2R2JATP	J24185229		1-	A	F2
R 1167	CHIP RES.	12k	1/16W	5%	RMC1/16 123JATP	J24185123		1-	B	c3
R 1168	CHIP RES.	470k	1/16W	1%	RMC1/16 474FTP	J24183474		1-70	A	A2
R 1168	CHIP RES.	470k	1/16W	1%	RMC1/16 474FTP	J24183474	TYP A	71-74	A	A2
R 1168	CHIP RES.	470k	1/16W	1%	RMC1/16 474FTP	J24183474	TYP C	71-74	A	A2
R 1168	CHIP RES.	330k	1/16W	1%	RMC1/16 334FTP	J24183334	TYP CS1	71-74	A	A2
R 1168	CHIP RES.	330k	1/16W	1%	RMC1/16 334FTP	J24183334		75-	A	A2
R 1169	CHIP RES.	33k	1/16W	5%	RMC1/16 333JATP	J24185333		1-	A	B3
R 1170	CHIP RES.	68k	1/16W	5%	RMC1/16 683JATP	J24185683		1-	A	B2
R 1171	CHIP RES.	2.2k	1/16W	5%	RMC1/16 222JATP	J24185222		1-	A	B1
R 1172	CHIP RES.	22k	1/16W	1%	RMC1/16 223FTP	J24183223		1-	A	B2
R 1173	CHIP RES.	100k	1/16W	5%	RMC1/16 104JATP	J24185104		1-	A	B2
R 1173	CHIP RES.	82k	1/16W	5%	RMC1/16 823JATP	J24185823		18-	A	B2
R 1174	CHIP RES.	2.2k	1/16W	5%	RMC1/16 222JATP	J24185222		1-	B	c1
R 1175	CHIP RES.	12k	1/16W	5%	RMC1/16 123JATP	J24185123		1-	B	c3
R 1176	CHIP RES.	10k	1/16W	1%	RMC1/16 103FTP	J24183103		1-	A	B2
R 1177	CHIP RES.	100k	1/16W	5%	RMC1/16 104JATP	J24185104		1-	A	B2
R 1181	CHIP RES.	0	1/16W	5%	RMC1/16 000JATP	J24185000		1-	B	e2
R 1182	CHIP RES.	47k	1/16W	5%	RMC1/16 473JATP	J24185473		1-	A	A1
R 1186	CHIP RES.	100	1/16W	5%	RMC1/16 101JATP	J24185101		1-	B	c2
R 1187	CHIP RES.	8.2k	1/16W	5%	RMC1/16 822JATP	J24185822		1-	B	c2
R 1188	CHIP RES.	3.3k	1/16W	5%	RMC1/16 332JATP	J24185332		1-	B	c2
R 1189	CHIP RES.	22k	1/16W	5%	RMC1/16 223JATP	J24185223		1-	A	A1
R 1190	CHIP RES.	470	1/16W	1%	RMC1/16 471FTP	J24183471		1-	A	A2
R 1190	CHIP RES.	560	1/16W	1%	RMC1/16 561FTP	J24183561		18-	A	A2
R 1191	CHIP RES.	100k	1/16W	1%	RMC1/16 104FTP	J24183104		1-	A	A2
R 1192	CHIP RES.	120k	1/16W	1%	RMC1/16 124FTP	J24183124		1-	A	A2
R 1192	CHIP RES.	100k	1/16W	1%	RMC1/16 104FTP	J24183104		18-	A	A2
R 1194	CHIP RES.	47k	1/16W	5%	RMC1/16 473JATP	J24185473		1-	B	f1
R 1196	CHIP RES.	4.7k	1/16W	5%	RMC1/16 472JATP	J24185472		1-	A	A2
R 1196	CHIP RES.	33k	1/16W	5%	RMC1/16 333JATP	J24185333		18-	A	A2
R 1197	CHIP RES.	220k	1/16W	5%	RMC1/16 224JATP	J24185224		1-	A	A2
R 1198	CHIP RES.	0	1/16W	5%	RMC1/16 000JATP	J24185000		1-	B	b2
R 1200	CHIP RES.	5.6k	1/16W	5%	RMC1/16 562JATP	J24185562		1-	A	B1
R 1202	CHIP RES.	47k	1/16W	5%	RMC1/16 473JATP	J24185473		1-	A	E2
R 1203	CHIP RES.	12k	1/16W	5%	RMC1/16 123JATP	J24185123		1-	B	c3
R 1204	CHIP RES.	12k	1/16W	5%	RMC1/16 123JATP	J24185123		1-	B	d3
R 1205	CHIP RES.	0	1/16W	5%	RMC1/16 000JATP	J24185000		1-	B	c1
R 1206	CHIP RES.	220	1/16W	5%	RMC1/16 221JATP	J24185221		1-	B	c1
R 1207	CHIP RES.	47k	1/16W	5%	RMC1/16 473JATP	J24185473	VX-180	1-	A	C1

REF.	DESCRIPTION	VALUE	V/W	TOL.	MFR'S DESIG	VXSTD P/N	VERS.	LOT.	SIDE	LAY ADR
R 1208	CHIP RES.	0	1/16W	5%	RMC1/16 000JATP	J24185000		1-31	A	D2
R 1208	CHIP RES.	0	1/16W	5%	RMC1/16 000JATP	J24185000	TYP A	45-	A	D2
R 1208	CHIP RES.	0	1/16W	5%	RMC1/16 000JATP	J24185000	TYP C	32-	A	D2
R 1209	CHIP RES.	3.3k	1/16W	5%	RMC1/16 332JATP	J24185332	VX-180	1-	B	d1
R 1210	CHIP RES.	2.2k	1/16W	5%	RMC1/16 222JATP	J24185222	VX-180	1-	B	d1
R 1212	CHIP RES.	100k	1/16W	5%	RMC1/16 104JATP	J24185104		1-	B	d2
R 1214	CHIP RES.	33	1/16W	5%	RMC1/16 330JATP	J24185330		1-	B	d1
R 1215	CHIP RES.	100k	1/16W	5%	RMC1/16 104JATP	J24185104	VX-180	1-	B	c1
R 1216	CHIP RES.	47k	1/16W	5%	RMC1/16 473JATP	J24185473		1-	B	d1
R 1217	CHIP RES.	22k	1/16W	5%	RMC1/16 223JATP	J24185223		1-	B	d1
R 1218	CHIP RES.	10k	1/16W	5%	RMC1/16 103JATP	J24185103		1-	B	d1
R 1219	CHIP RES.	3.3k	1/16W	5%	RMC1/16 332JATP	J24185332		1-	B	e2
R 1220	CHIP RES.	8.2k	1/16W	5%	RMC1/16 822JATP	J24185822		1-	B	e2
R 1221	CHIP RES.	68	1/16W	5%	RMC1/16 680JATP	J24185680		1-	B	b1
R 1222	CHIP RES.	12k	1/16W	5%	RMC1/16 123JATP	J24185123		1-	A	E1
R 1222	CHIP RES.	12k	1/16W	5%	RMC1/16 123JATP	J24185123		50-	A	E1
R 1222	CHIP RES.	47k	1/16W	5%	RMC1/16 473JATP	J24185473		54-	A	E1
R 1223	CHIP RES.	390	1/16W	5%	RMC1/16 391JATP	J24185391	VX-180	1-	A	C3
R 1224	CHIP RES.	10k	1/16W	5%	RMC1/16 103JATP	J24185103		1-	A	A2
R 1225	CHIP RES.	10k	1/16W	5%	RMC1/16 103JATP	J24185103		1-	B	f2
R 1226	CHIP RES.	22k	1/16W	5%	RMC1/16 223JATP	J24185223		1-	B	f1
R 1227	CHIP RES.	39k	1/16W	5%	RMC1/16 393JATP	J24185393		1-	B	f1
R 1228	CHIP RES.	82k	1/16W	5%	RMC1/16 823JATP	J24185823		1-	B	f1
R 1229	CHIP RES.	100k	1/16W	5%	RMC1/16 104JATP	J24185104		1-	B	d1
R 1230	CHIP RES.	100k	1/16W	5%	RMC1/16 104JATP	J24185104		1-	B	e1
R 1231	CHIP RES.	100k	1/16W	5%	RMC1/16 104JATP	J24185104		1-	B	e1
R 1232	CHIP RES.	100k	1/16W	5%	RMC1/16 104JATP	J24185104		1-	B	e1
R 1233	CHIP RES.	6.8k	1/16W	5%	RMC1/16 682JATP	J24185682		1-	B	e1
R 1234	CHIP RES.	10k	1/16W	5%	RMC1/16 103JATP	J24185103		1-	B	e2
R 1235	CHIP RES.	3.3k	1/16W	5%	RMC1/16 332JATP	J24185332		1-	A	B1
R 1236	CHIP RES.	2.2M	1/16W	5%	RMC1/16 225JATP	J24185225		1-	A	B2
R 1237	CHIP RES.	1k	1/16W	5%	RMC1/16 102JATP	J24185102		1-	B	e1
R 1238	CHIP RES.	1k	1/16W	5%	RMC1/16 102JATP	J24185102		1-	B	e1
R 1239	CHIP RES.	1k	1/16W	5%	RMC1/16 102JATP	J24185102		1-	B	e1
R 1240	CHIP RES.	1k	1/16W	5%	RMC1/16 102JATP	J24185102		1-	B	e1
R 1241	CHIP RES.	33	1/16W	5%	RMC1/16 330JATP	J24185330		1-	B	d1
R 1242	CHIP RES.	0	1/16W	5%	RMC1/16 000JATP	J24185000		1-	A	D3
R 1243	CHIP RES.	0	1/16W	5%	RMC1/16 000JATP	J24185000		1-	A	D3
R 1244	CHIP RES.	0	1/16W	5%	RMC1/16 000JATP	J24185000		1-	A	D2
R 1245	CHIP RES.	0	1/16W	5%	RMC1/16 000JATP	J24185000		1-	A	D2
R 1246	CHIP RES.	0	1/16W	5%	RMC1/16 000JATP	J24185000		1-	A	D3
R 1247	CHIP RES.	0	1/10W	5%	RMC1/10T 000J	J24205000		1-	A	E1
R 1249	CHIP RES.	10k	1/16W	5%	RMC1/16 103JATP	J24185103		1-	A	A2
R 1250	CHIP RES.	4.7k	1/16W	5%	RMC1/16 472JATP	J24185472		1-	A	A3
R 1251	CHIP RES.	22k	1/16W	5%	RMC1/16 223JATP	J24185223		1-	A	A1
R 1252	CHIP RES.	22k	1/16W	5%	RMC1/16 223JATP	J24185223		1-	A	A1
R 1253	CHIP RES.	390	1/16W	5%	RMC1/16 391JATP	J24185391	VX-180	1-	A	C1
R 1256	CHIP RES.	22k	1/16W	5%	RMC1/16 223JATP	J24185223		1-	A	E2
R 1258	CHIP RES.	0	1/16W	5%	RMC1/16 000JATP	J24185000		1-	A	B2
R 1260	CHIP RES.	820k	1/16W	5%	RMC1/16 824JATP	J24185824		1-	A	A2
R 1261	CHIP RES.	0	1/16W	5%	RMC1/16 000JATP	J24185000		1-	B	e2
R 1262	CHIP RES.	100k	1/16W	5%	RMC1/16 104JATP	J24185104		18-	A	A2
R 1263	CHIP RES.	0	1/16W	5%	RMC1/16 000JATP	J24185000		18-	A	A2
R 1264	CHIP RES.	0	1/16W	5%	RMC1/16 000JATP	J24185000	TYP CS1	61-		
R 1264	CHIP RES.	0	1/16W	5%	RMC1/16 000JATP	J24185000	TYP CS1	100-		
R 1265	CHIP RES.	0	1/16W	5%	RMC1/16 000JATP	J24185000		100-	A	E1
S 1001	ROTARY SWITCH				EC10SP16-85A0	Q9000764		1-	B	a2
S 1002	TACT SWITCH				SKHLLD	N5090066		1-	B	b1
S 1003	TACT SWITCH				SKHLLD	N5090066		1-	B	c1
TH1004	THERMISTOR				TBPS1R103K440H5Q	G9090067		1-	B	d1
VR1006	POT.				RK0971111 20KA/SW	J60800256		1-	B	a3
X 1001	XTAL SX-2112	14.6MHz			14.6MHZ	H0103237		1-	B	d2
X 1001	XTAL SX-2112	14.6MHz			14.6MHZ	H0103260		3-	B	d2
X 1002	XTAL SX-1319	3.6864MHz			3.6864MHZ	H0103214		1-	B	e1

# MAIN Unit

REF.	DESCRIPTION	VALUE	V/W	TOL.	MFR'S DESIG	VXSTD P/N	VERS.	LOT.	SIDE	LAY ADR
X 1002	XTAL U3B	3.6864MHz			3.686400MHz (11p)	H0103307		76-	B	e1
XF1001	XTAL FILTER				HDF0051 44.25M	H1102358	TYP CS1	32-	B	b2
XF1002	XTAL FILTER				HDF0042 44.25MHZ	H1102346		1-31	B	b2
XF1002	XTAL FILTER				HDF0042 44.25MHZ	H1102346	TYP A	45-	B	b2
XF1002	XTAL FILTER				HDF0042 44.25MHZ	H1102346	TYP C	32-	B	b2
XF1002	XTAL FILTER				HDF0051 44.25M	H1102358	TYP CS1	32-	B	b2
	INTER CONNECTOR					RA0294800	VX-180	1-		
	LCD HOLDER					RA0294400	VX-180	1-		
	LIGHT GUIDE				(LCD)	RA0294500	VX-180	1-		
	LIGHT GUIDE				(LCD)	RA029450A	VX-180	10-		
	LIGHT GUIDE				(LCD)	RA029450B	VX-180	76-		
	TERMINAL HOLDER					RA010340A		1-		
	TERMINAL HOLDER					RA010340B		28-		
	TERMINAL PLATE				(+)	RA0351700		1-		
	HOLDER RUBBER				(MIC)	RA0110200		1-		
	REFLECTOR SHEET					RA033490A	VX-180	1-		







Copyright 2004  
VERTEX STANDARD CO., LTD.  
All rights reserved

No portion of this manual  
may be reproduced without  
the permission of  
VERTEX STANDARD CO., LTD.

